

Information Visualization

Mirco Schönfeld
University of Bayreuth

mirco.schoenfeld@uni-bayreuth.de
[@TWlyY29](https://twitter.com/TWlyY29)

minard.txt ✕

```

1 basic
2 input,
3 (lonc latc city$ lont temp days date$ lonp latp surviv direc$ division),
4 (#4 #5 > $12 >> #5 #5 #5 $8 #6 #6 >> #6 >> $1 #3)
5 save minard
6 run
7 24.0 55.0 Kowno ..... 37.6 0 6 Oct 18 24.0 54.9 340000 A 1
8 25.3 54.7 Wilna ..... 36.0 0 6 Oct 24 24.5 55.0 340000 A 1
9 26.4 54.4 Smorgoni ..... 33.2 -9 16 Nov 9 25.5 54.5 340000 A 1
10 26.8 54.3 Molodexno ..... 32.0 -21 5 Nov 14 26.0 54.7 320000 A 1
11 27.7 55.2 Gloubokoe ..... 29.2 -11 10 ..... 27.0 54.8 300000 A 1
12 27.6 53.9 Minsk ..... 28.5 -20 4 Nov 28 28.0 54.9 280000 A 1
13 28.5 54.3 Studienska ..... 27.2 -24 3 Dec 1 28.5 55.0 240000 A 1
14 28.7 55.5 Polotzk ..... 26.7 -30 5 Dec 6 29.0 55.1 210000 A 1
15 29.2 54.4 Bobr ..... 25.3 -26 1 Dec 7 30.0 55.2 180000 A 1
16 30.2 55.3 Witebsk ..... 30.3 55.3 175000 A 1
17 30.4 54.5 Orscha ..... 32.0 54.8 145000 A 1
18 30.4 53.9 Mohilow ..... 33.2 54.9 140000 A 1
19 32.0 54.8 Smolensk ..... 34.4 55.5 127100 A 1
20 33.2 54.9 Dorogobouge ..... 35.5 55.4 100000 A 1
21 34.3 55.2 Wixma ..... 36.0 55.5 100000 A 1
22 34.4 55.5 Chjat ..... 37.6 55.8 100000 R 1
23 36.0 55.5 Mojaisk ..... 37.5 55.7 98000 R 1
24 37.6 55.8 Moscou ..... 37.0 55.0 97000 R 1
25 36.6 55.3 Tarantino ..... 36.8 55.0 96000 R 1
26 36.5 55.0 Malo-jarosewli ..... 35.4 55.3 87000 R 1
27 ..... 34.3 55.2 55000 R 1
28 ..... 33.3 54.8 37000 R 1

```

Carte Figurative des pertes successives en hommes de l'Armée Française dans la campagne de Russie 1812-1813.
 Dressée par M. Minard, Inspecteur Général des Ponts et Chaussées en retraite. Paris, le 20 Novembre 1869.

Les nombres d'hommes présents sont représentés par les largeurs des zones colorées à raison d'un millimètre pour dix mille hommes; ils sont de plus écrits en travers des zones. Le rouge désigne les hommes qui entrent en Russie, le noir ceux qui en sortent. — Les renseignements qui ont servi à dresser la carte ont été puisés dans les ouvrages de M.M. Chiers, de Ségur, de Fezensac, de Chambray et le journal inédit de Jacob, pharmacien de l'Armée depuis le 28 Octobre. Pour mieux faire juger à l'œil la diminution de l'armée, j'ai supposé que les corps du Prince Jérôme et du Maréchal Davoust qui avaient été détachés sur Minsk et Mohilow et ont rejoint vers Orscha et Witebsk, avaient toujours marché avec l'armée.



TABLEAU GRAPHIQUE de la température en degrés du thermomètre de Réaumur au dessous de zéro.



Autog. par Regnier, 8. Par. 5^{ème} Marie St G^{ème} à Paris.

Imp. Lith. Regnier et Dourdet.

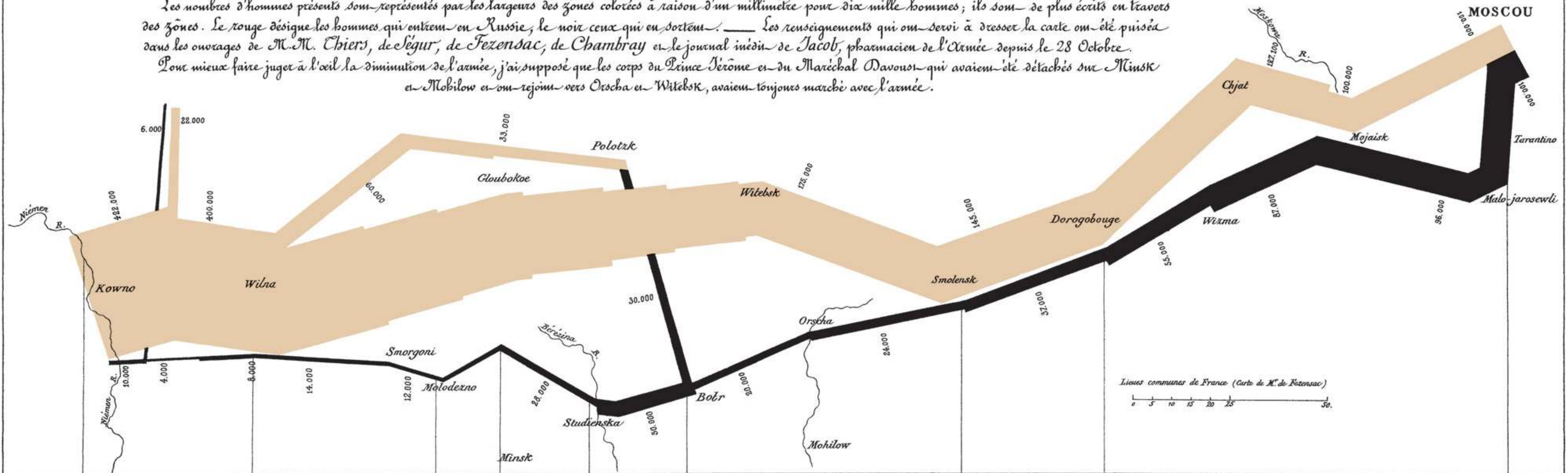
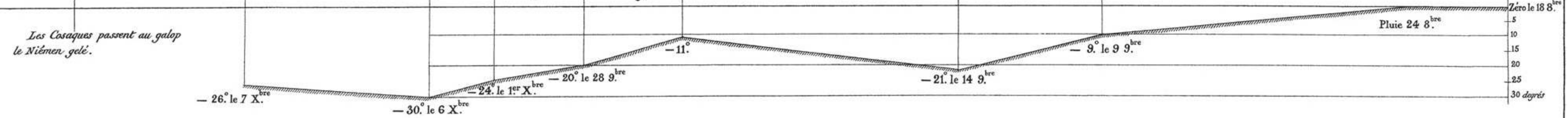
Information Visualization is a Form of Communication

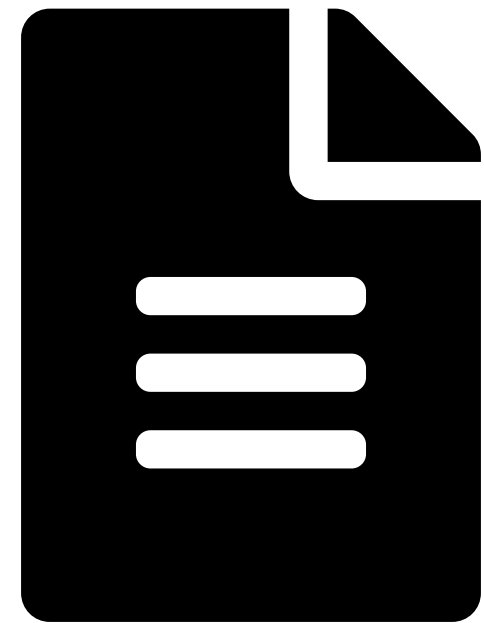

encoding

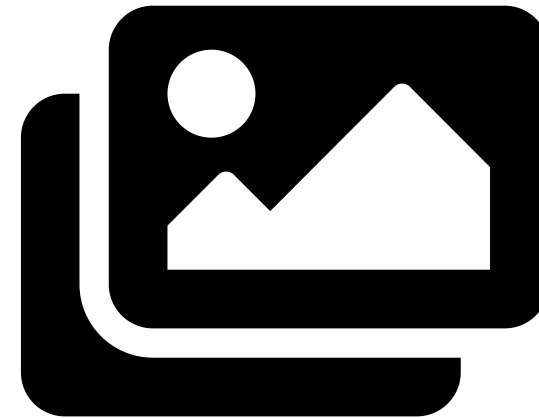

decoding

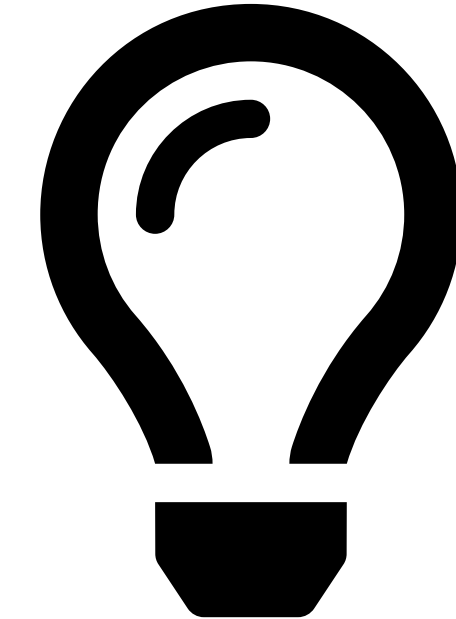

Encoding:
Multivariate data is represented in two-dimensional space

Decoding:
Derive information from data

Goal:
Show the data and avoid distortion
Reveal different levels of detail
Induce the viewer to think about the substance of data
Tell a story with your data

How our brain works:
Brain is great at processing pictures (high bandwidth)
People think in pictures
Pattern recognition
Pre-attentive perception

Joseph Priestley (1733-1804)

English chemist, natural philosopher, theologian, political theorist...

Created the first timeline chart

A Specimen of a Chart of Biography.

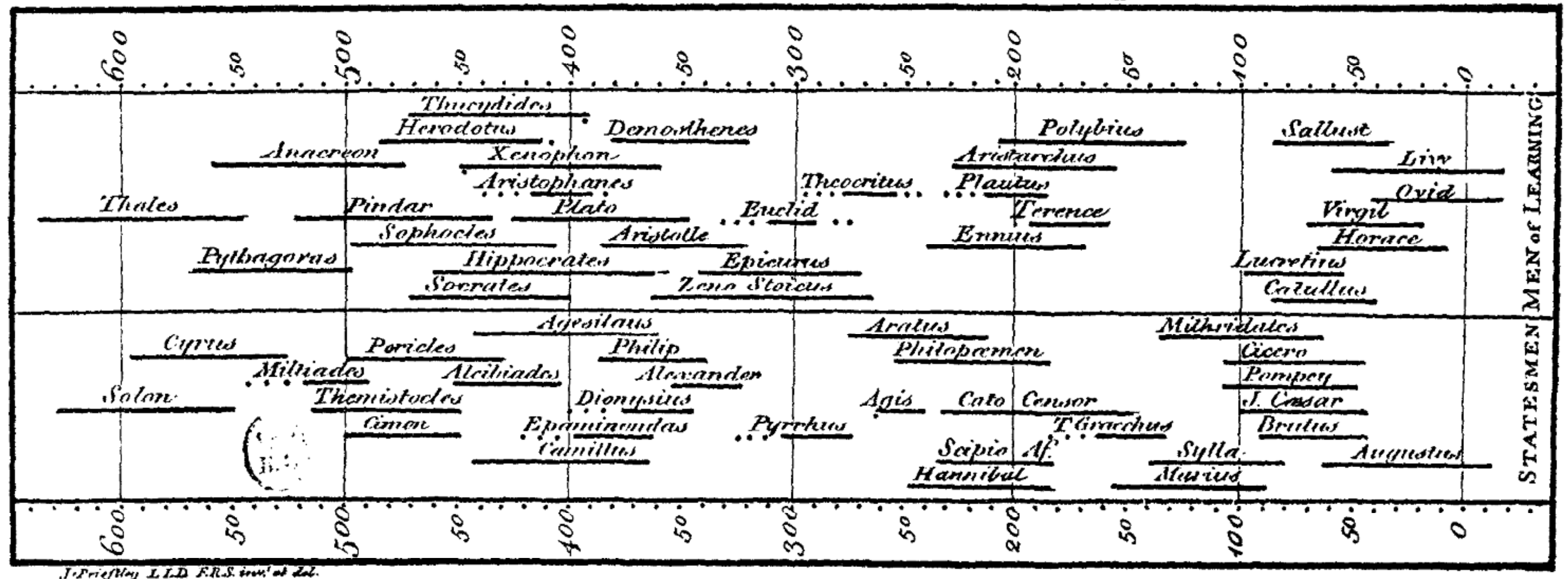

William Playfair (1759-1823)

Founder of graphical statistics

Commercial and
Political Atlas, 1786

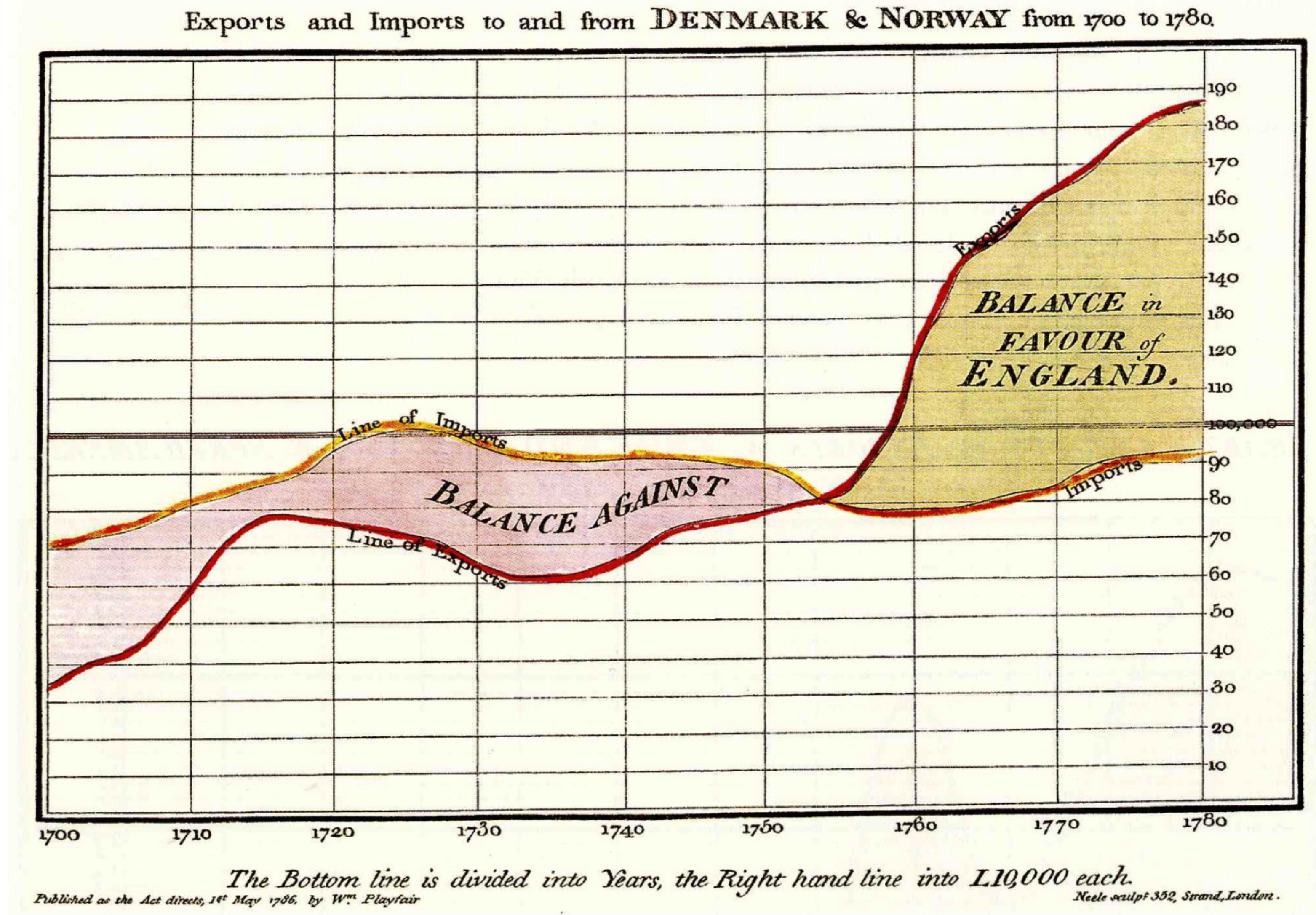

William Playfair (1759-1823)

1786: Bar Chart

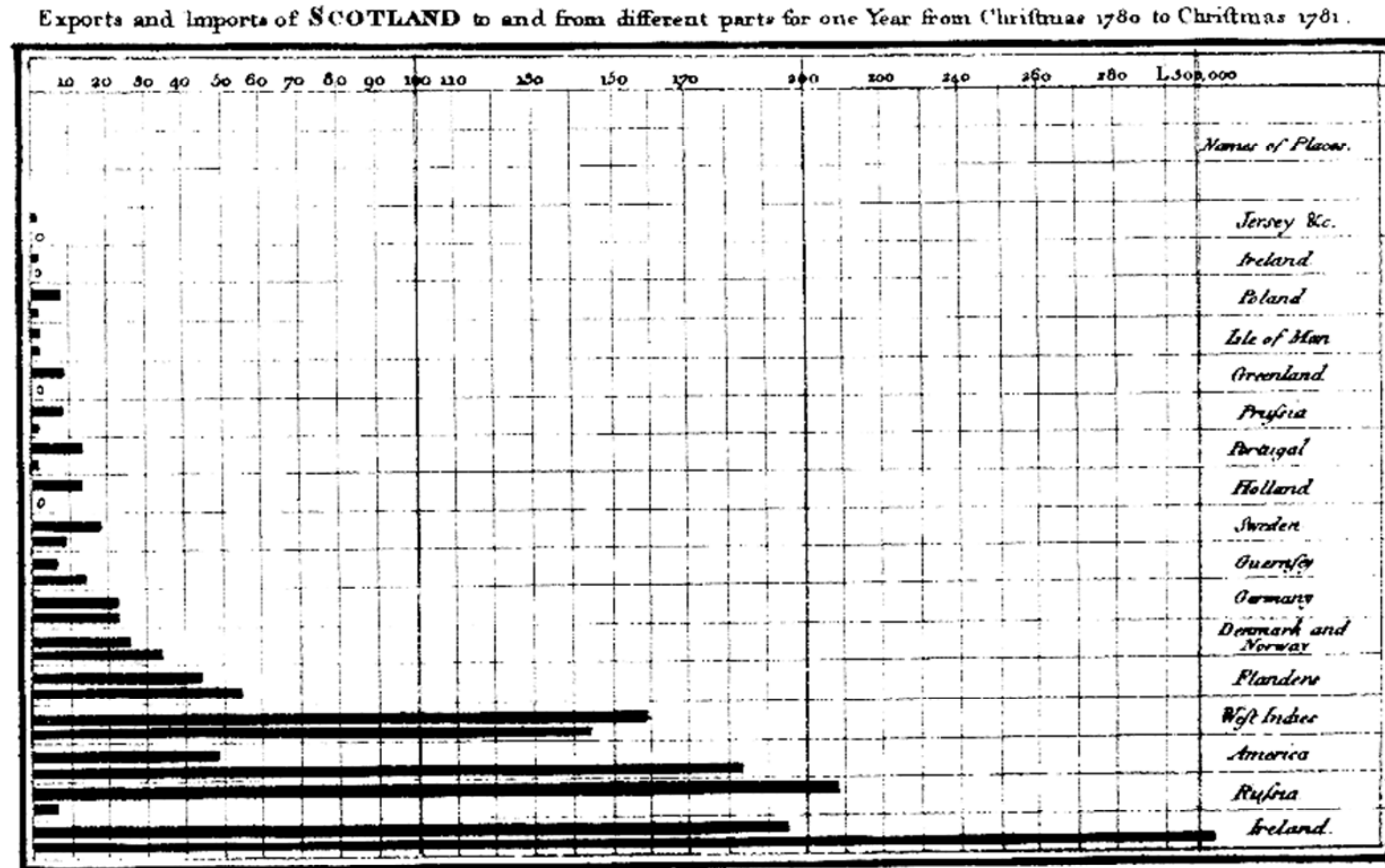

The Upright divisions are Ten Thousand Pounds each. The Black Lines are Exports the Ribbed lines Imports.

Published in the Act done June 7th 1781 by W^m Playfair

Printed by J. Smith, Strand, London.

William Playfair (1759-1823)

1801: Pie Chart and Circle Graph

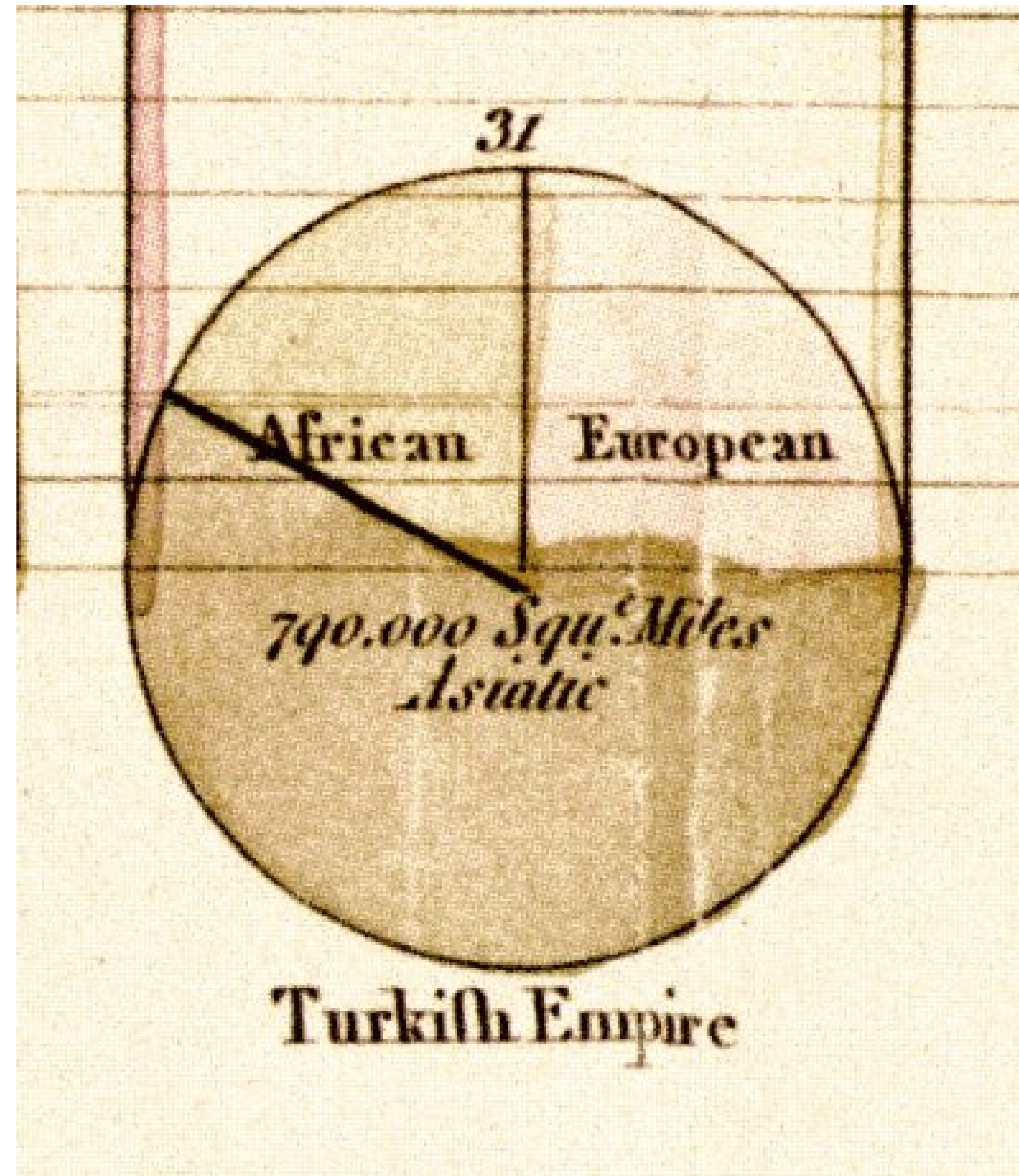

William Playfair (1759-1823)

1821: Multivariate Visualization

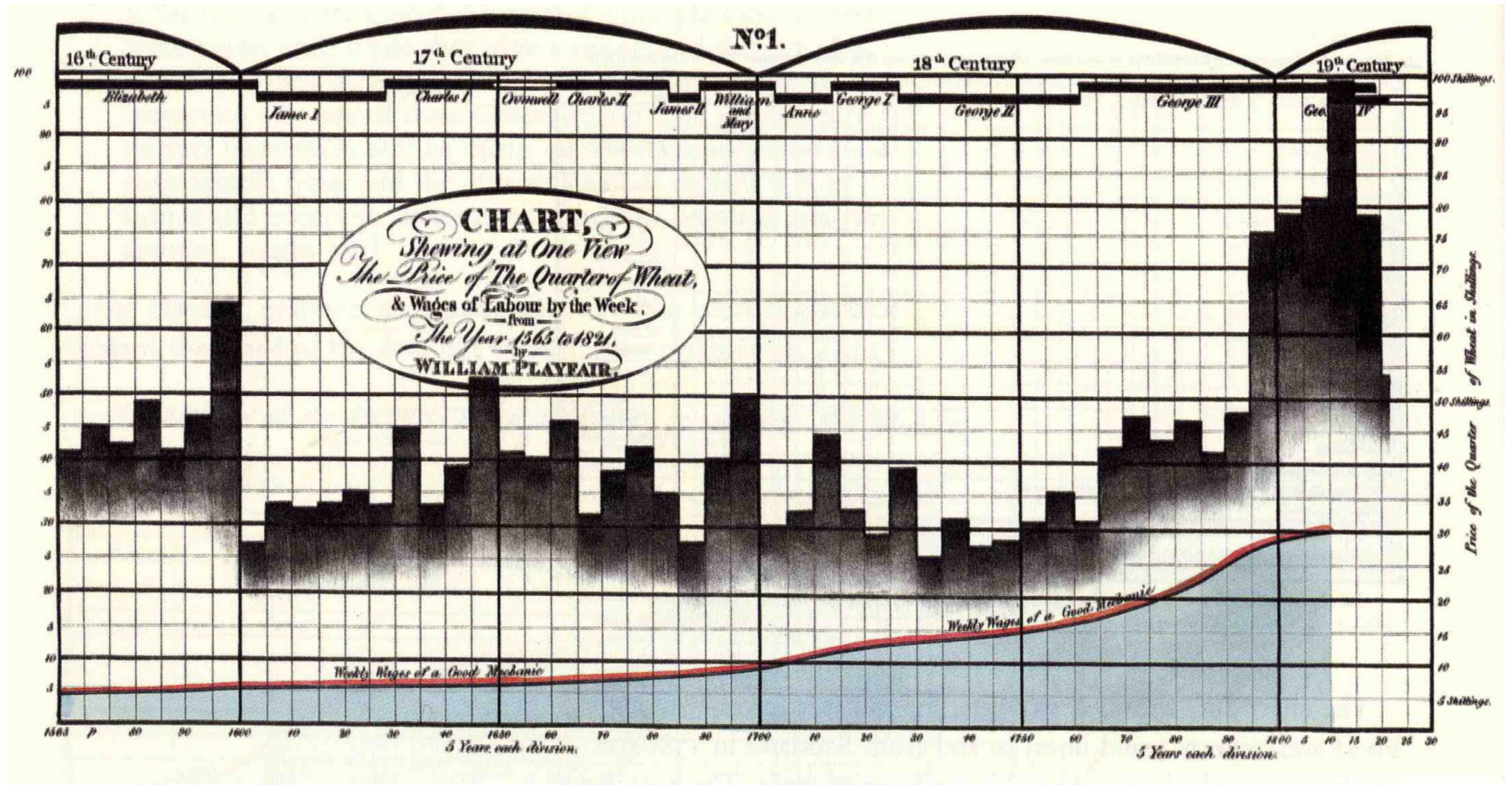

John Snow (1813-1858)

English physician

Data visualization for reasoning

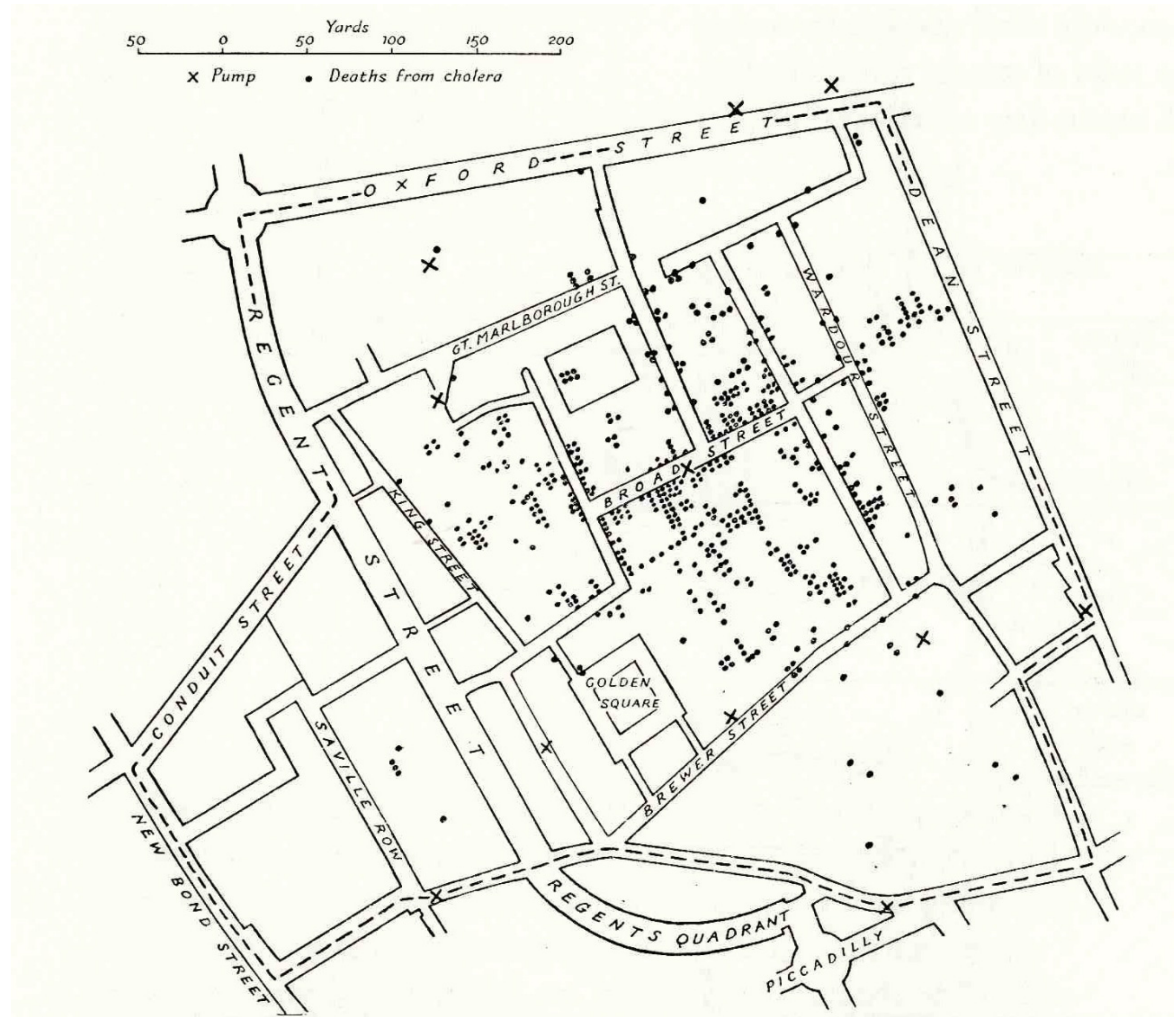

Highlighting: Preattentive Perception



Do you see a red circle?

A preattentive task coming up...

You will see a series of pictures, some with a red circle in it.

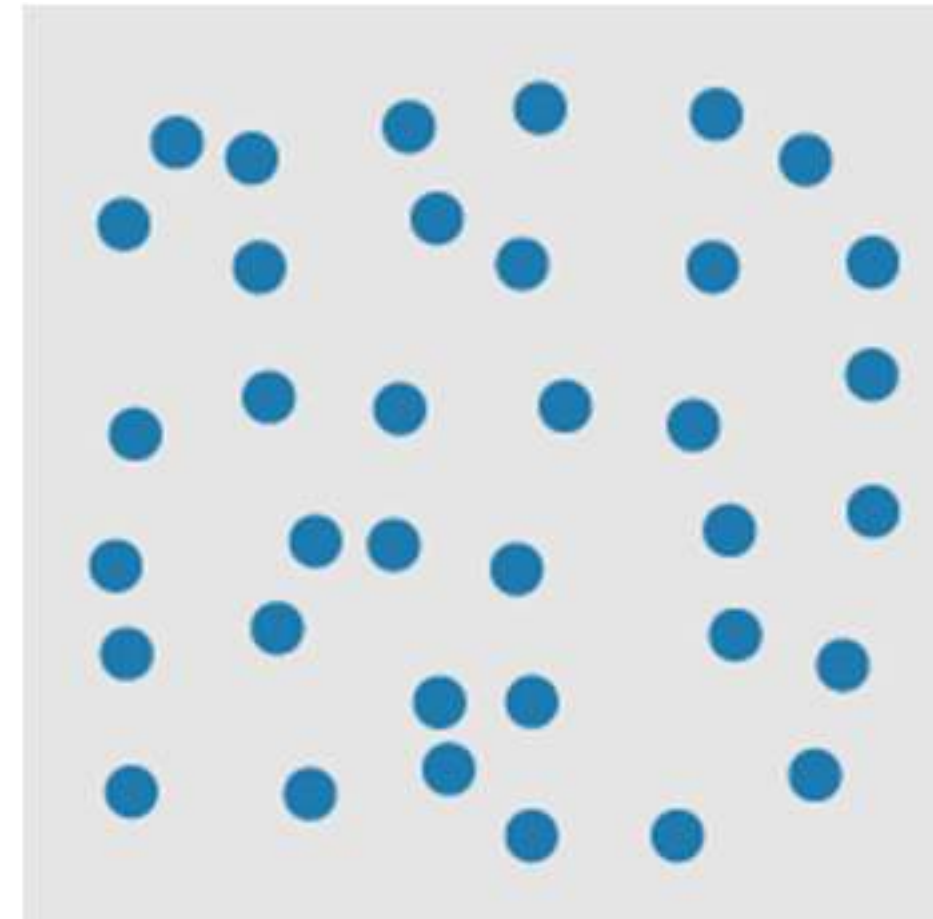

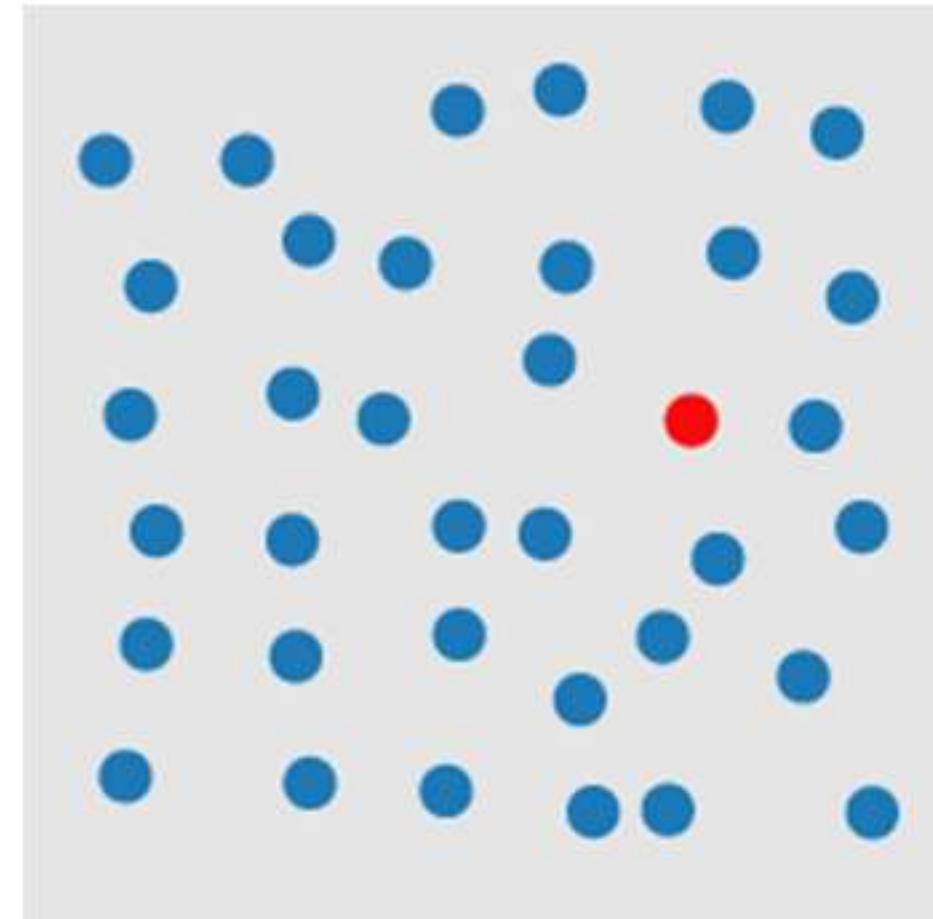

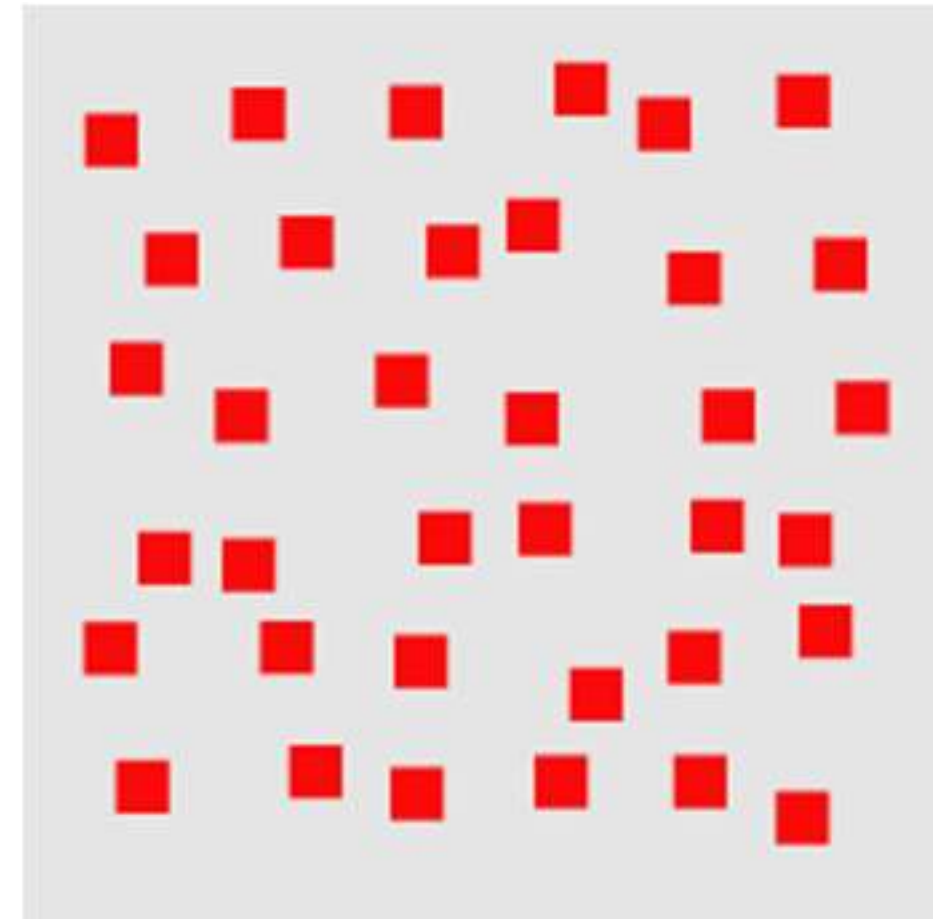

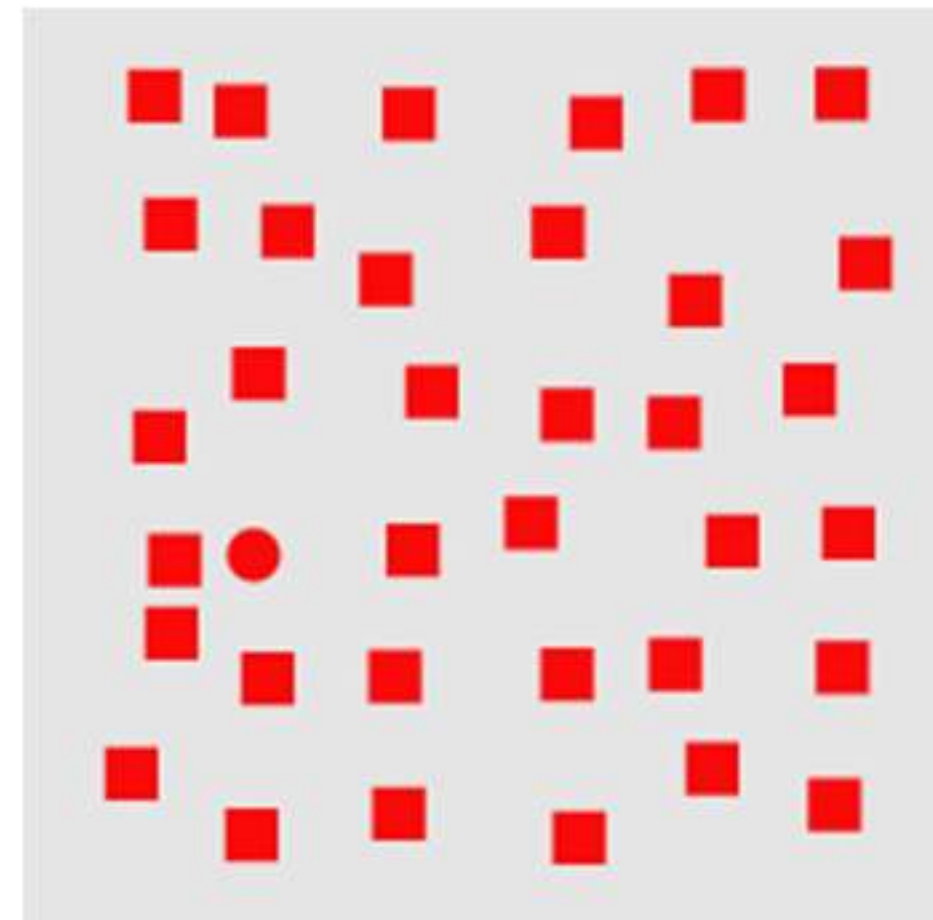

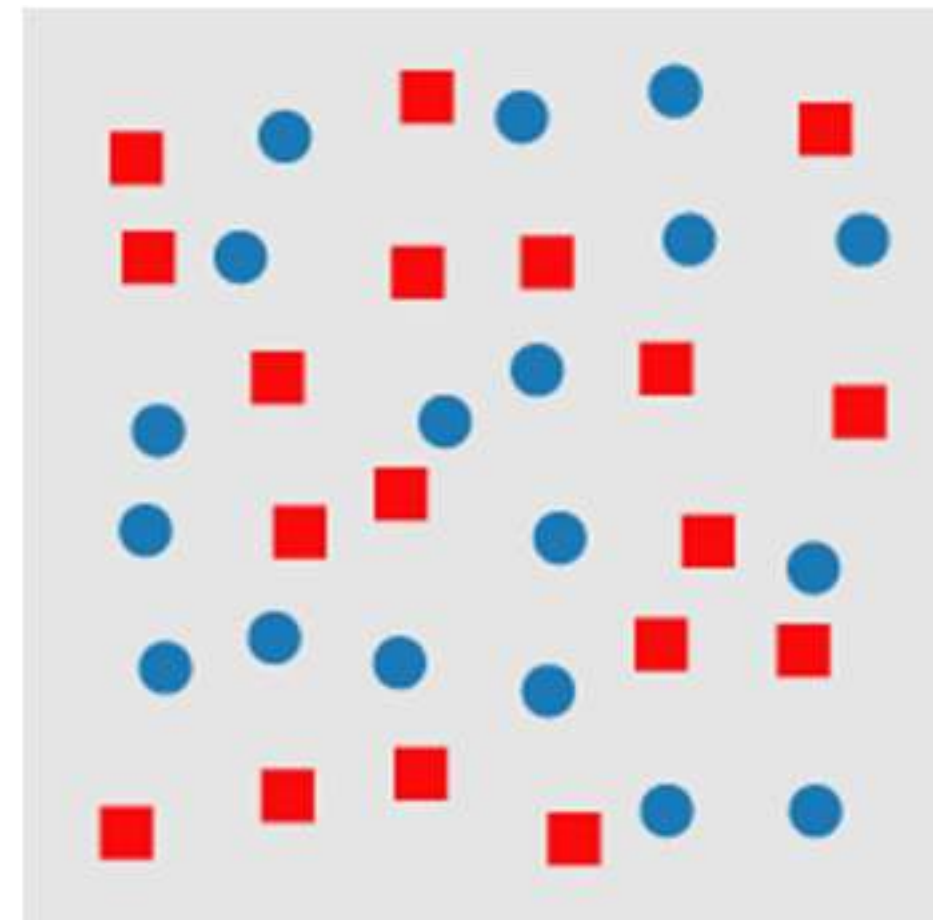

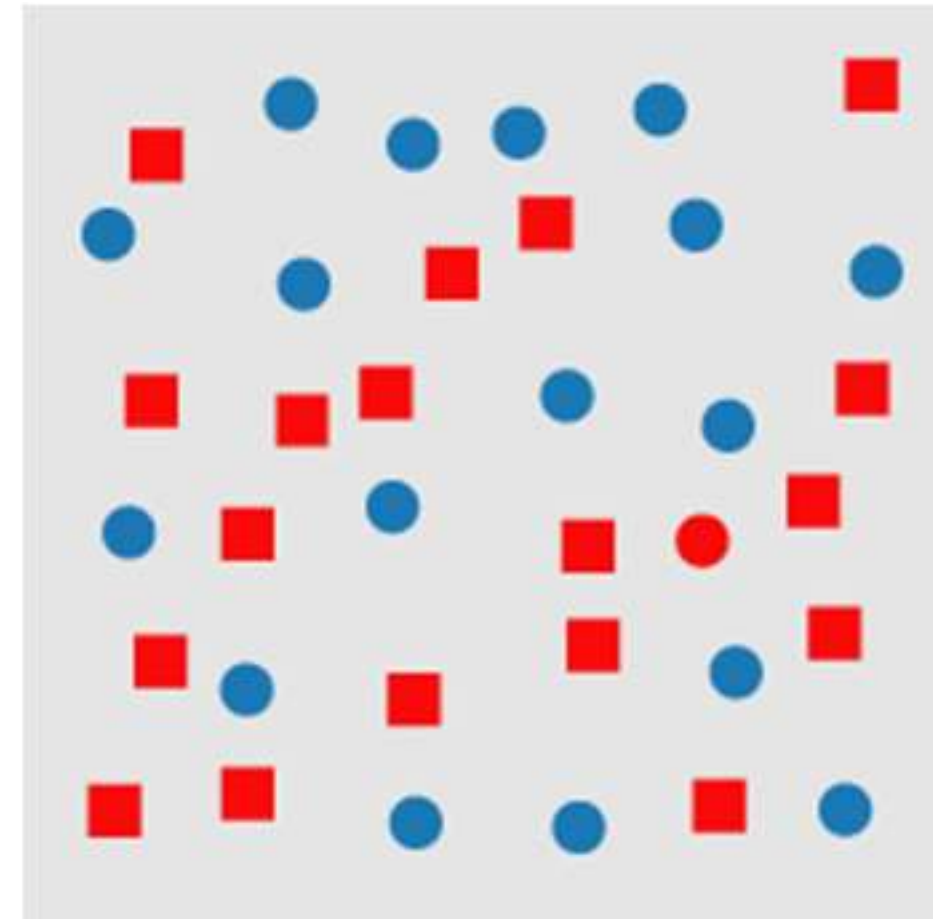

Did you see a red circle?

A unique visual property in the target allows it to „pop out“ of a display

Combination of non-unique features cannot be processed preattentively

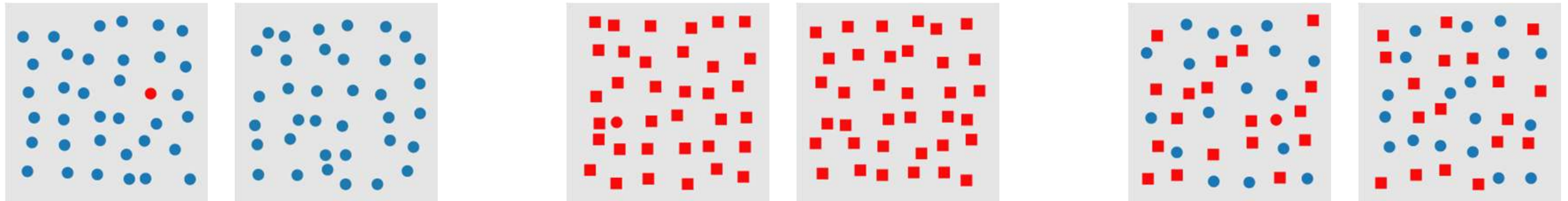

Preattentive Processing

Neuroscientific concept

Can be thought of to occur before conscious attention

Usually detected by measuring the time to find a target element among distractors

Exploited in information visualization to show things „at a glance“

- Element detection
- Grouping
- Value Estimation
- Importance

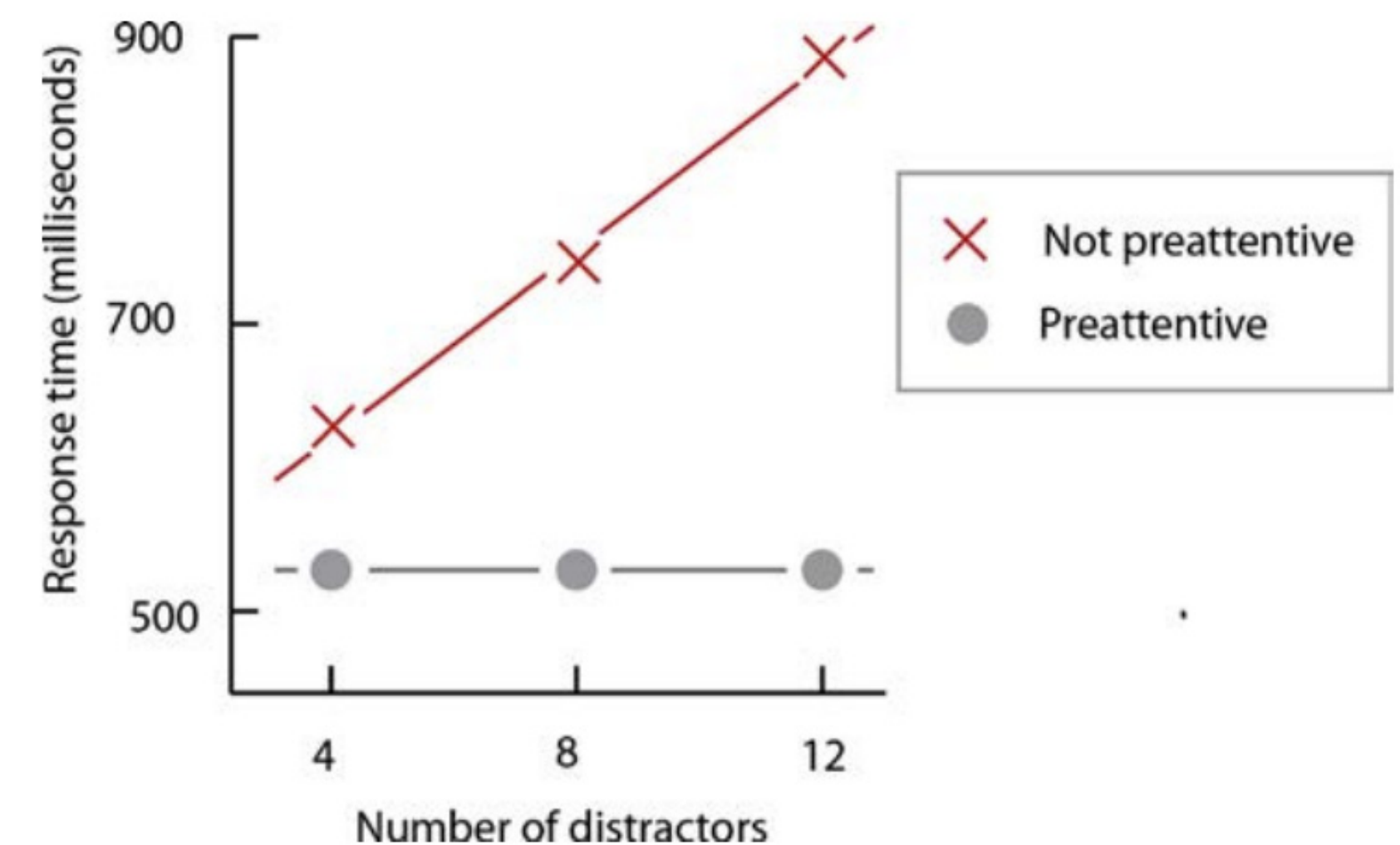

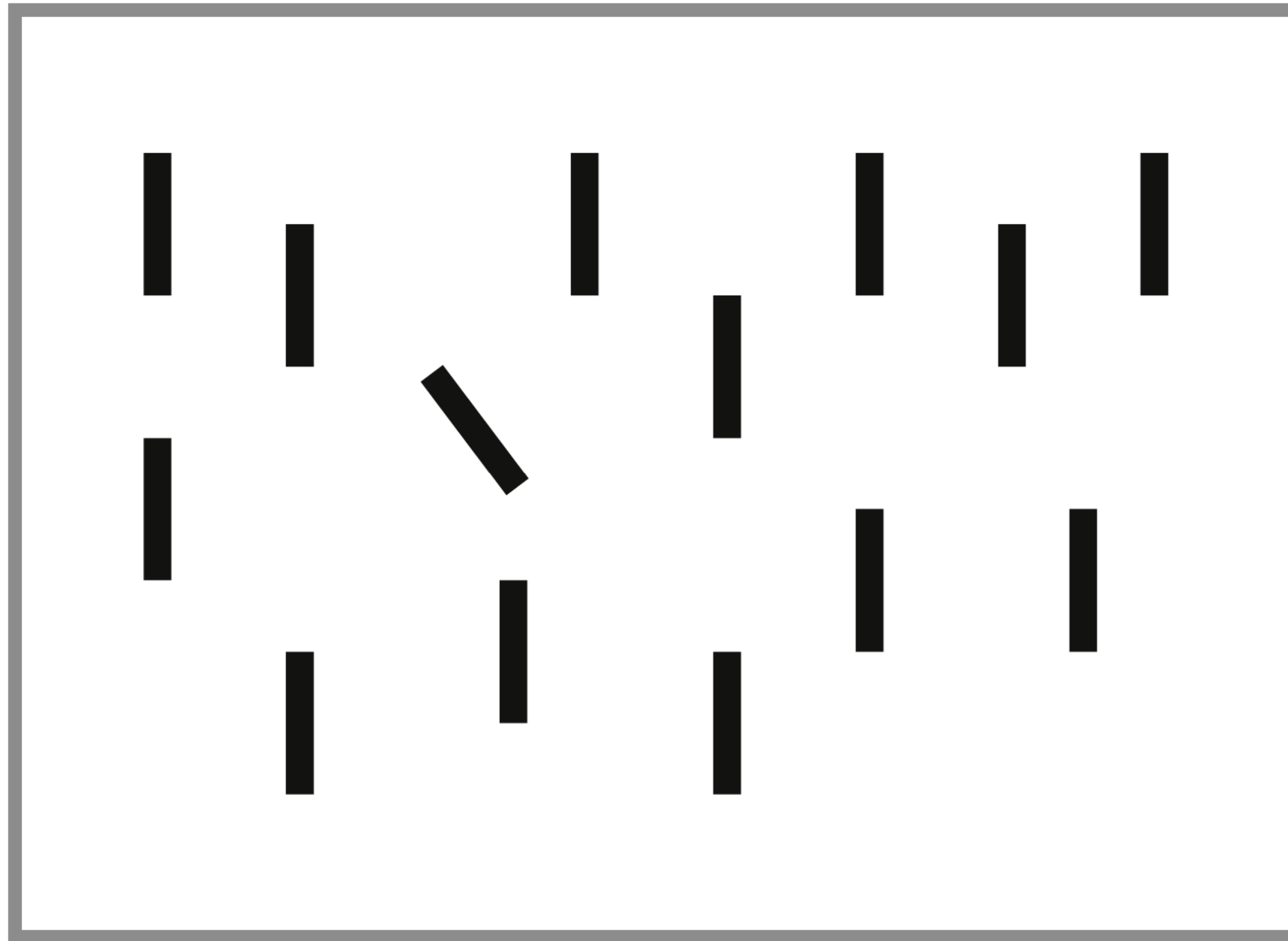

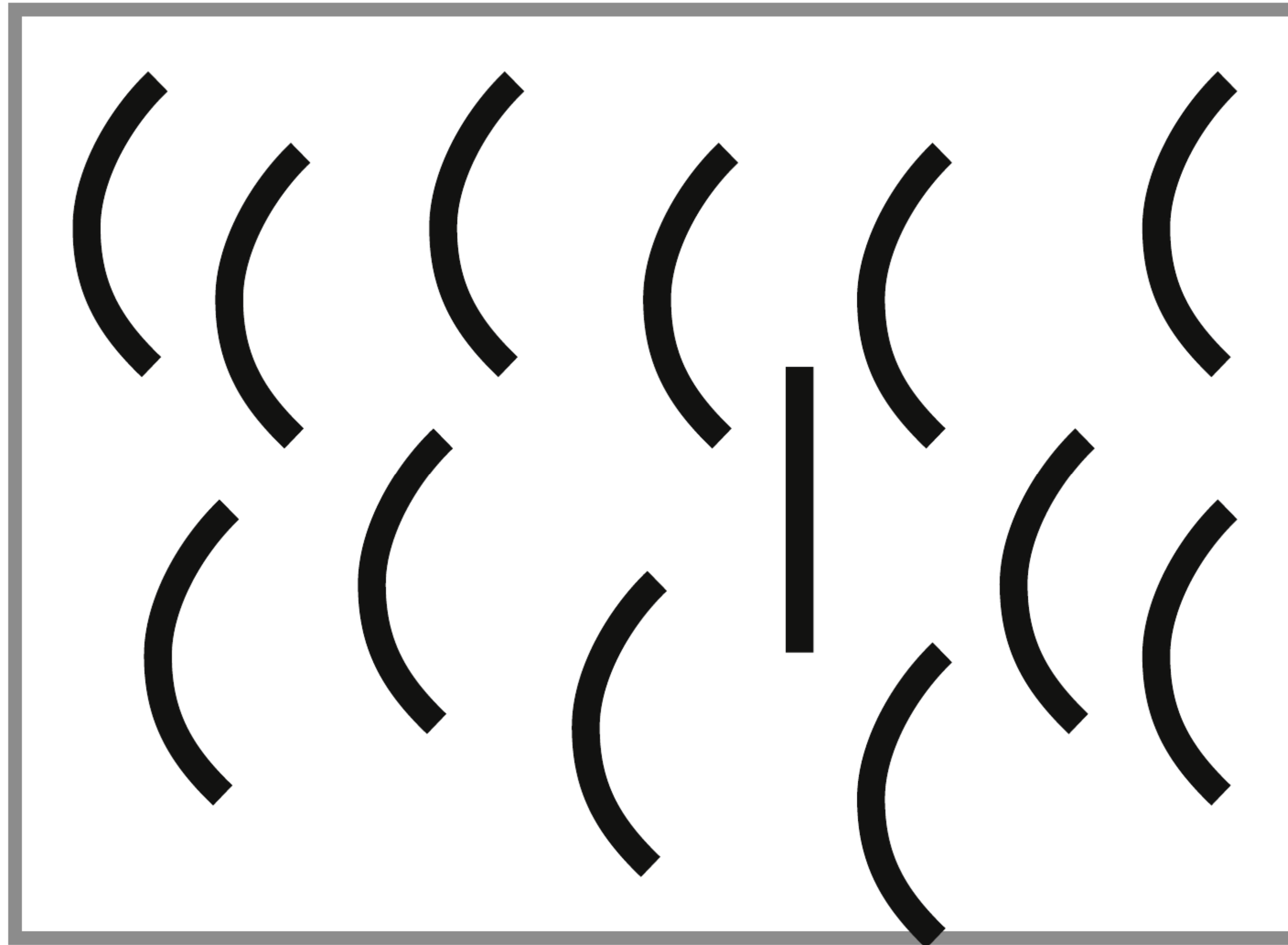

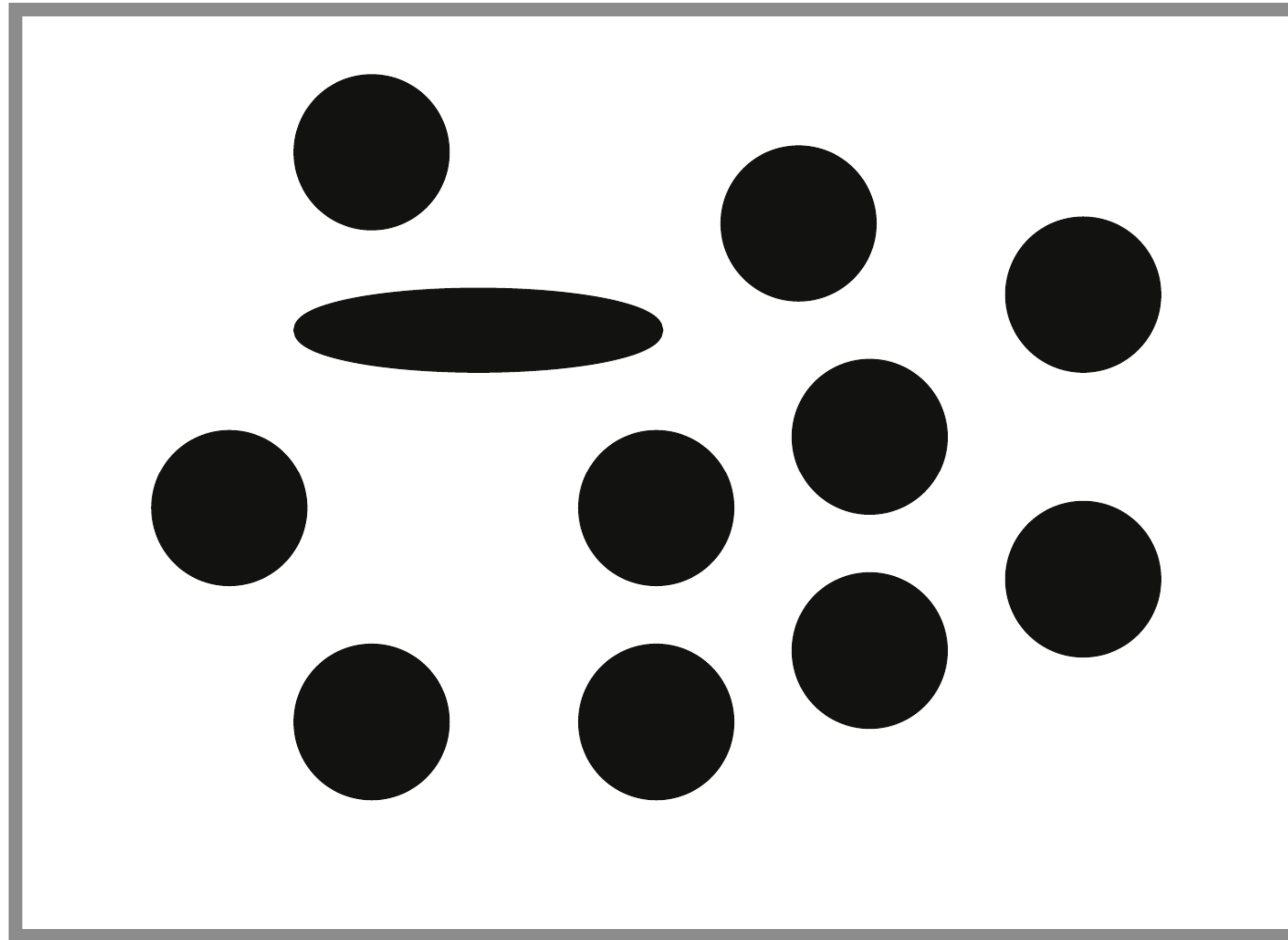

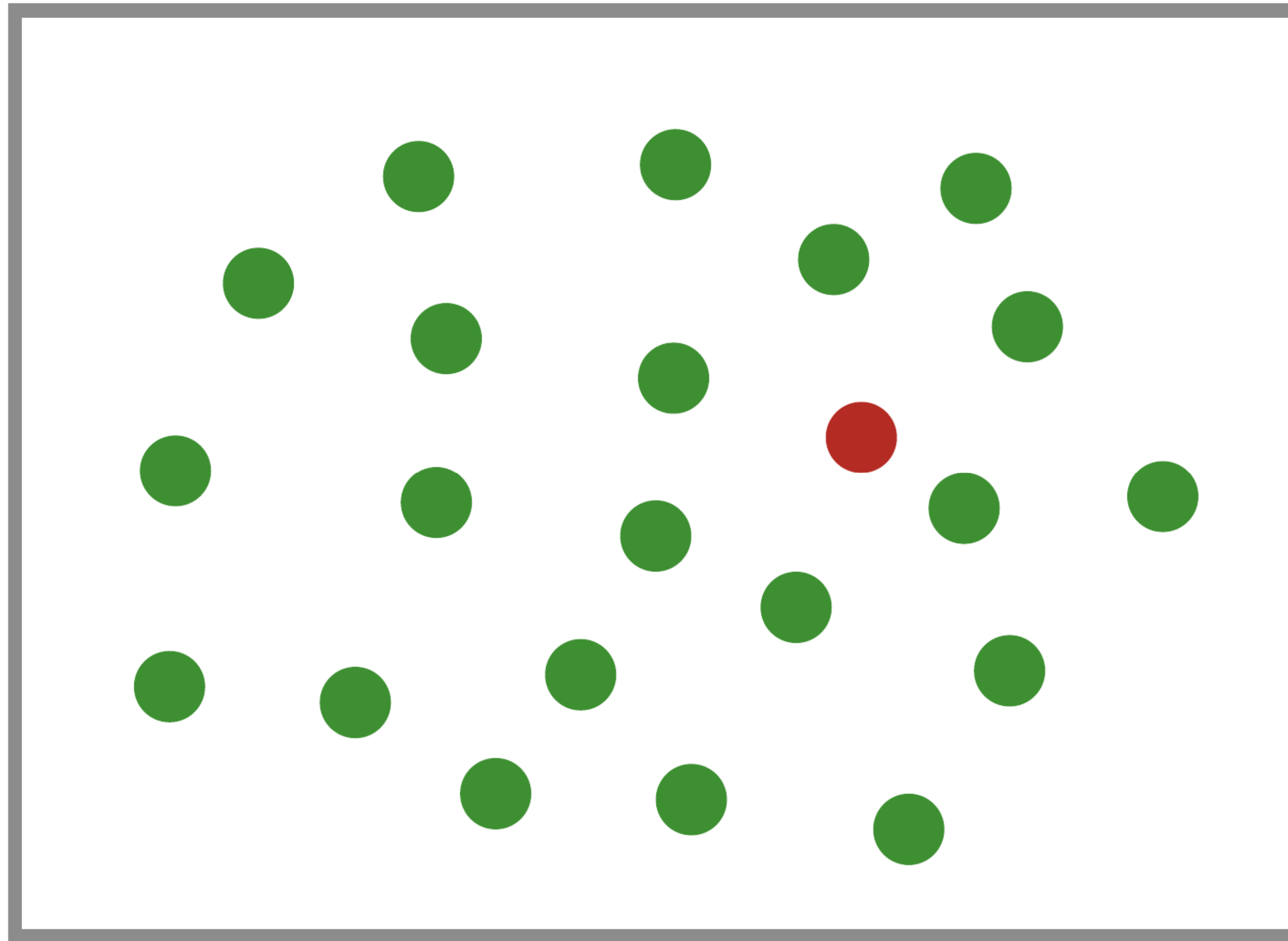

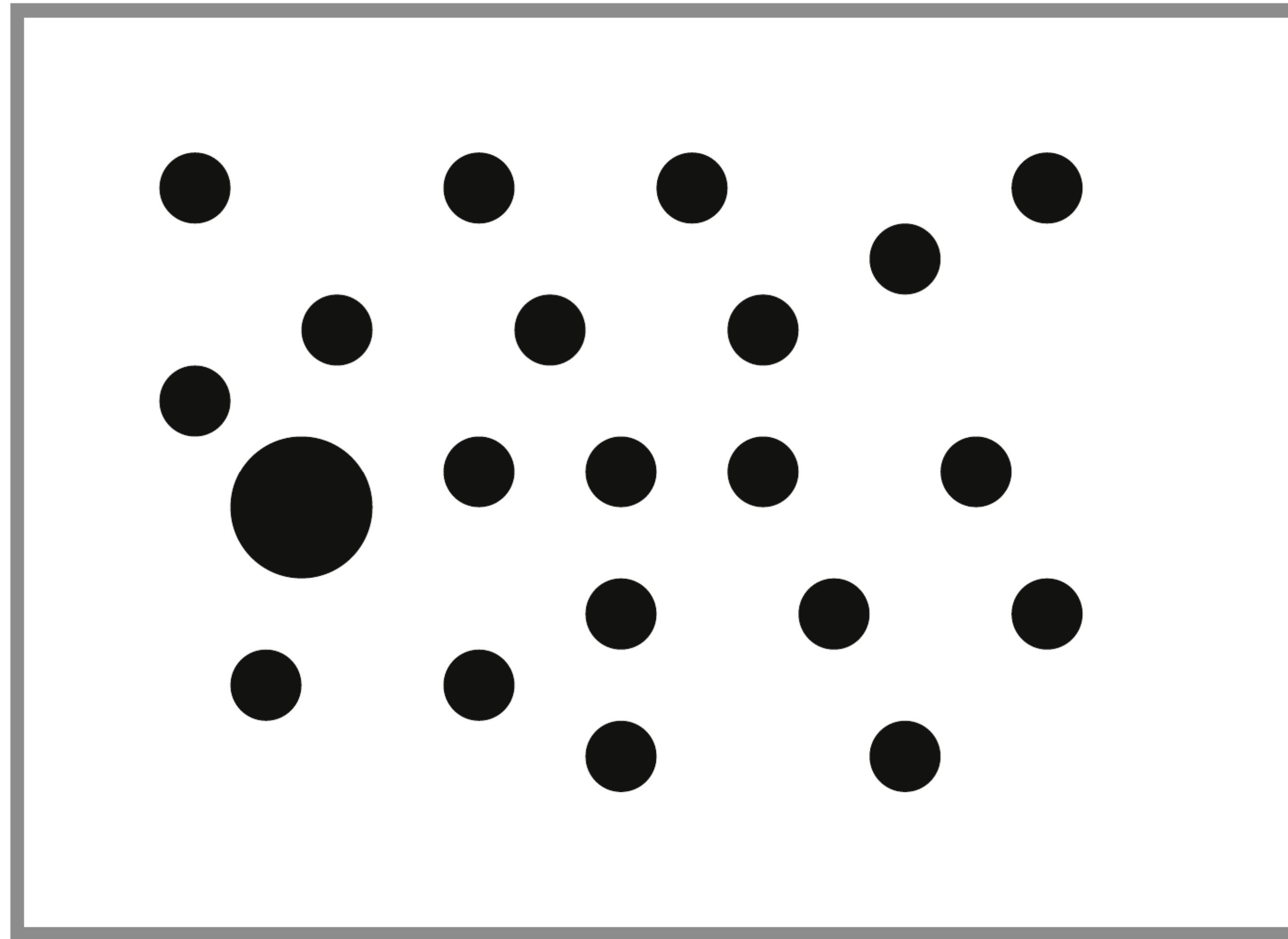

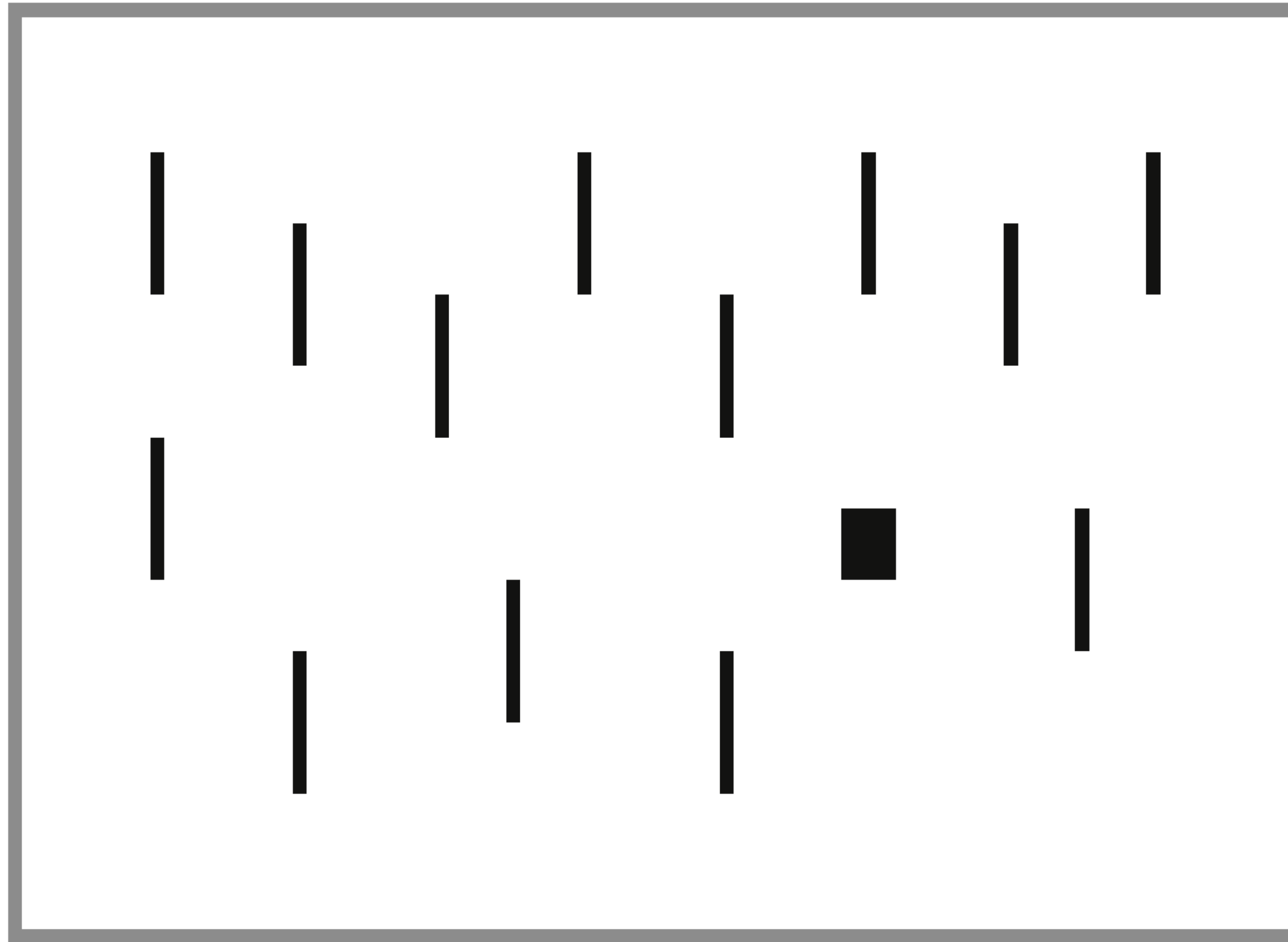

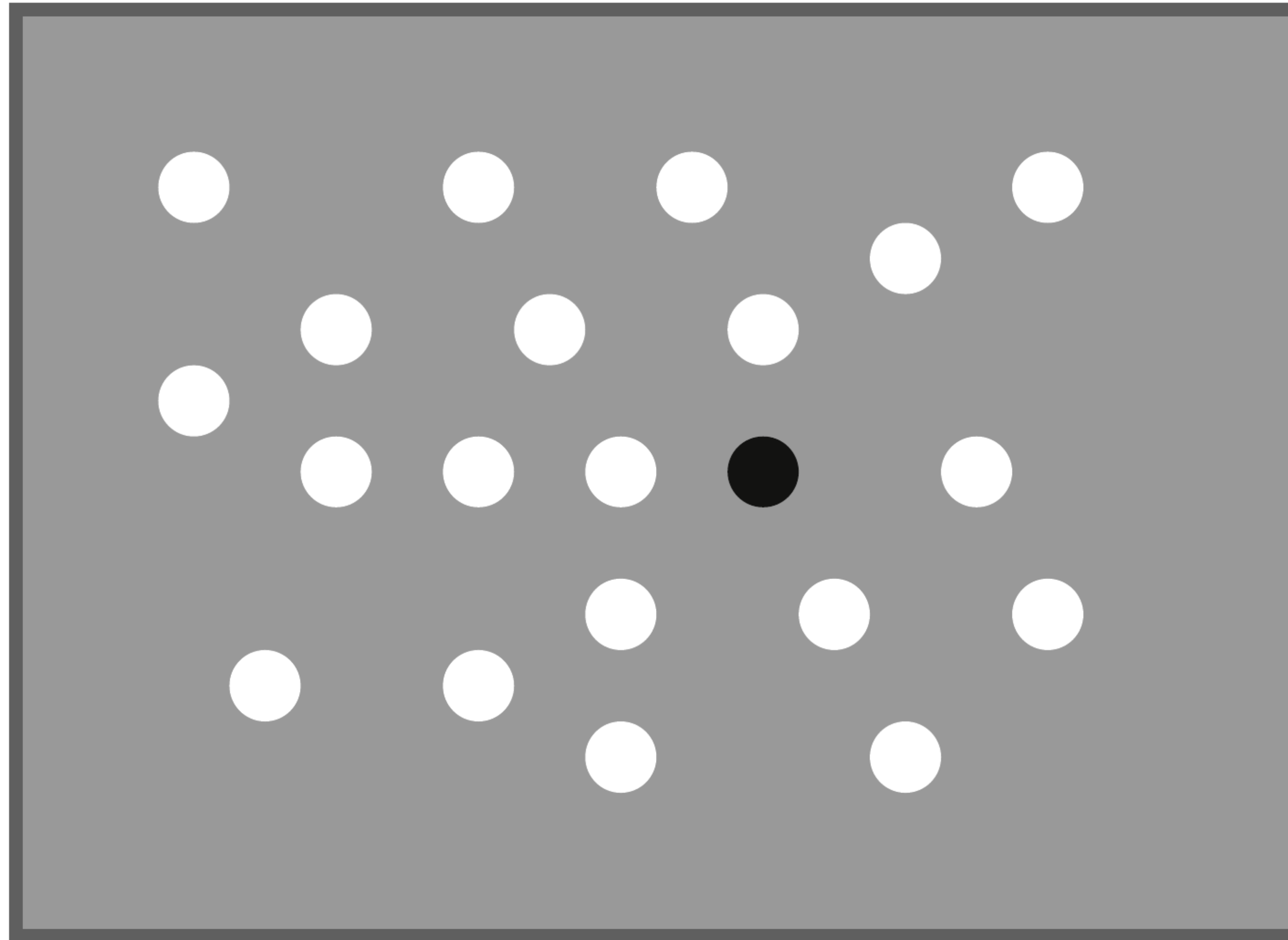

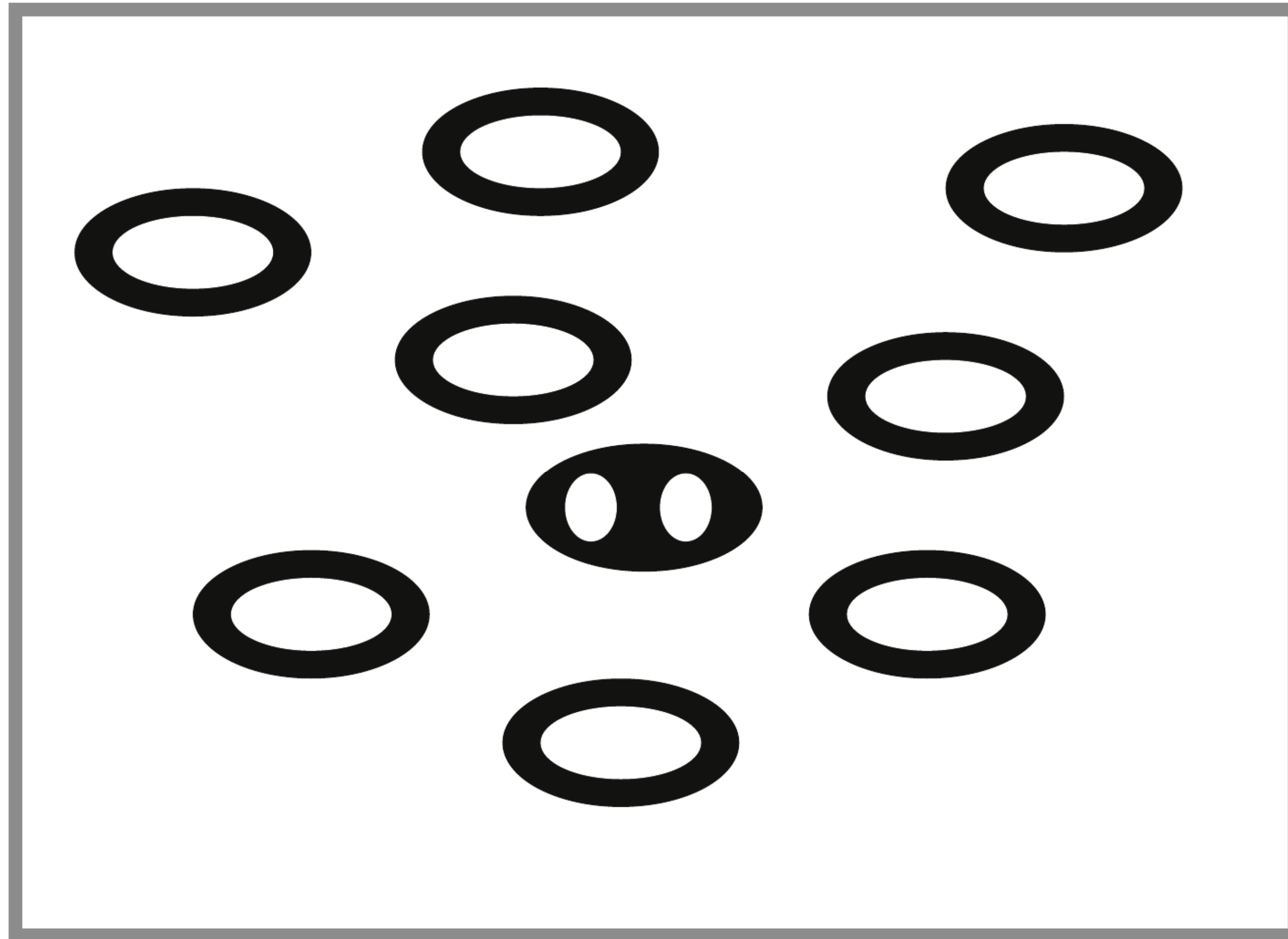

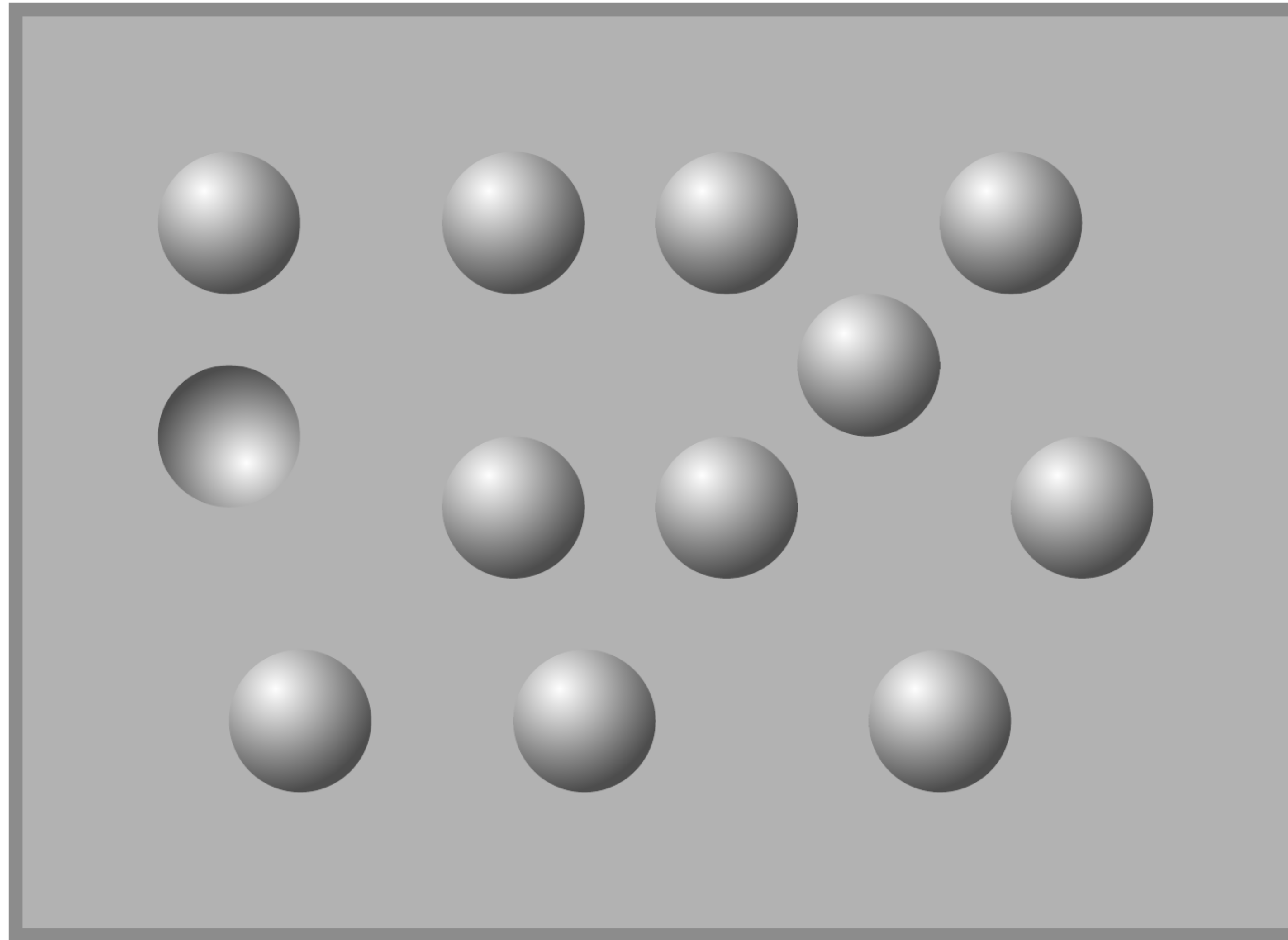

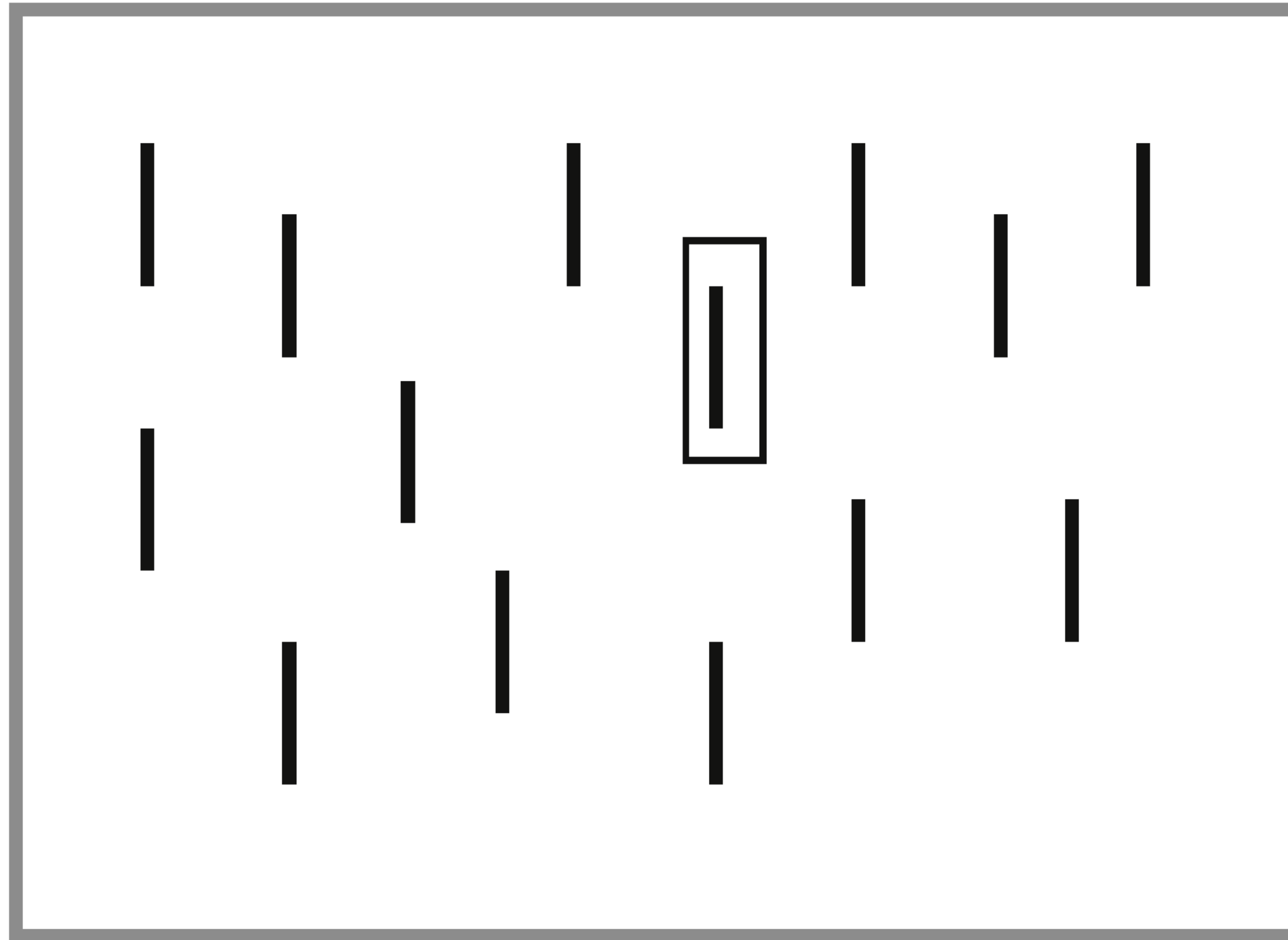

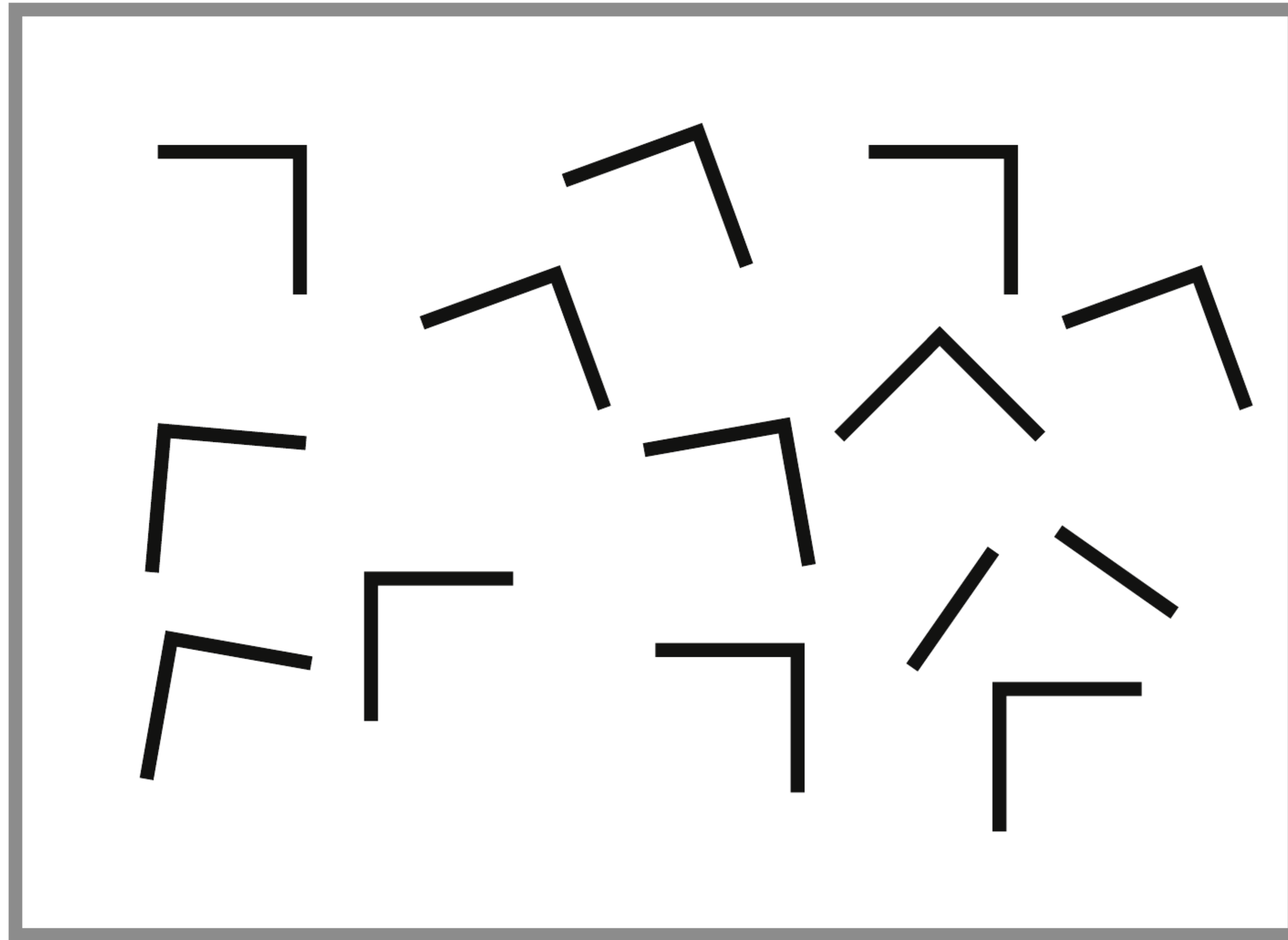

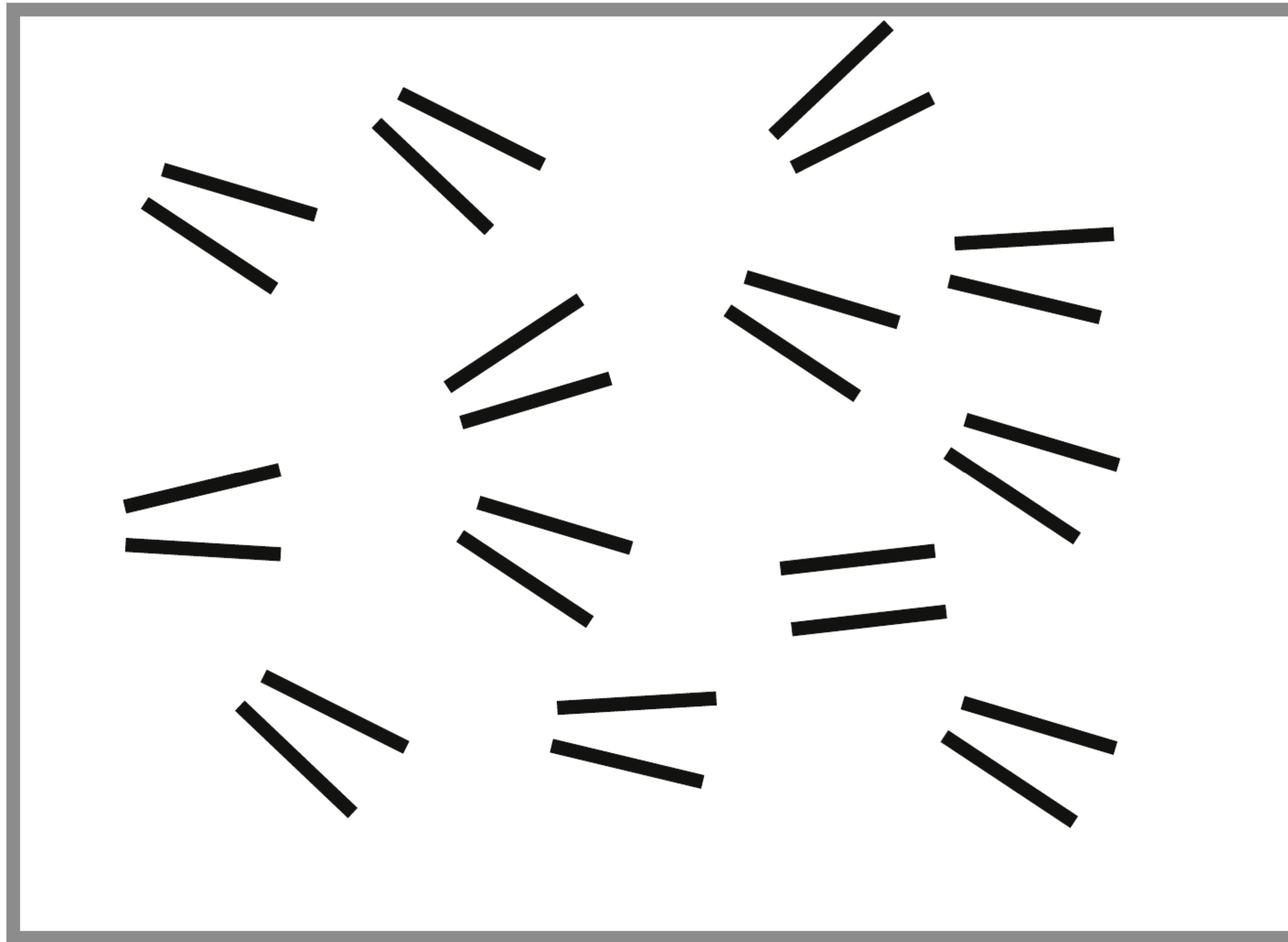



Preattentive Elements

Not all preattentive effects are equally strong

Attributes that guide the deployment of attention most:

- Color
- Motion
- Orientation
- Size (including length and spatial frequency)

Other attributes are probable, but supported by less studies or with controversial results

Graphical Elements

Graphical Elements

- Position : x,y location
- Size : length or area
- Shape : form
- Orientation : alignment
- Value : brightness
- Texture : patterns
- Color : hue & saturation

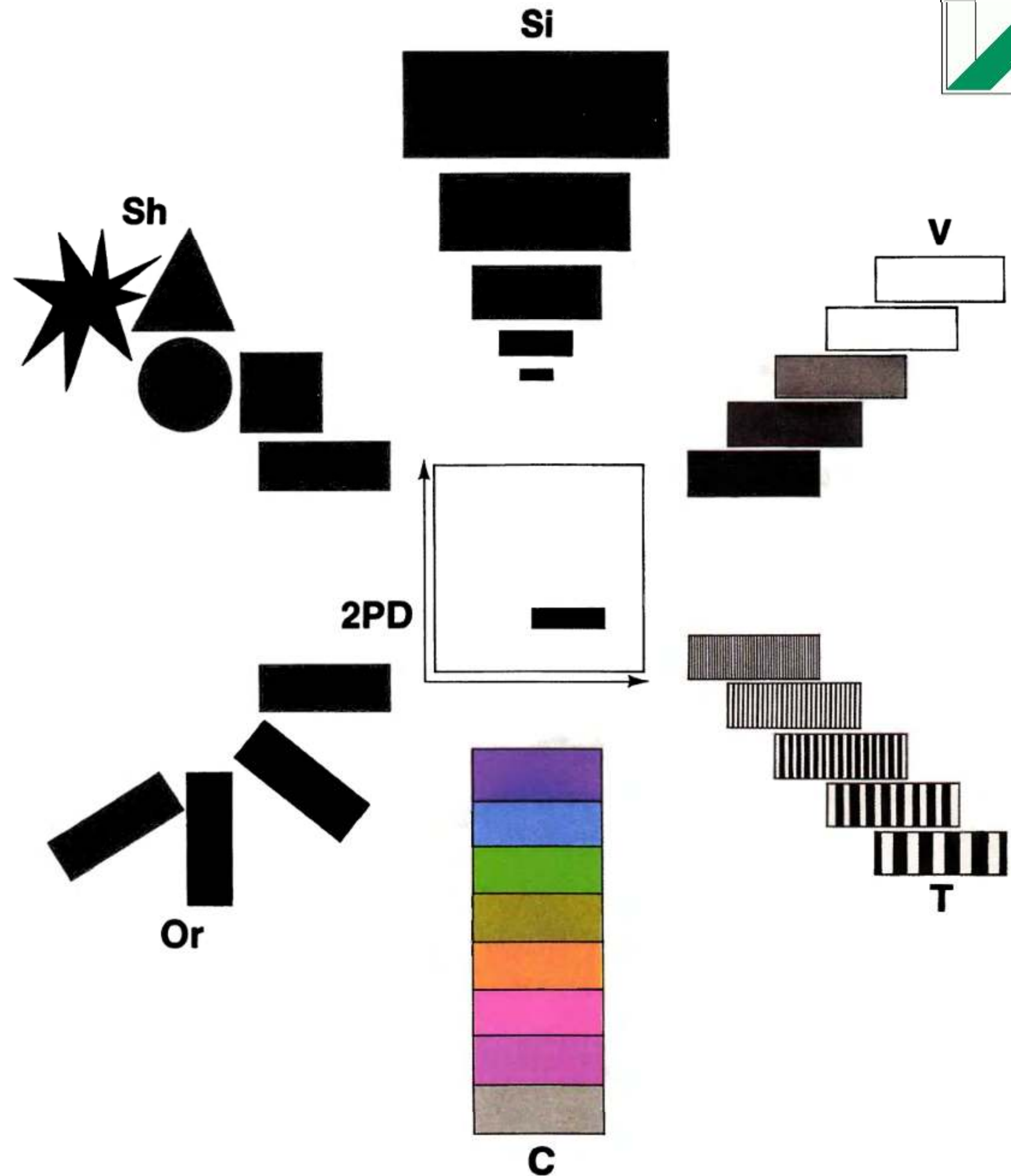

Graphical Elements: Size & Value

Great for showing

- Different intensities
- Different magnitudes
- More/less
- Larger/smaller

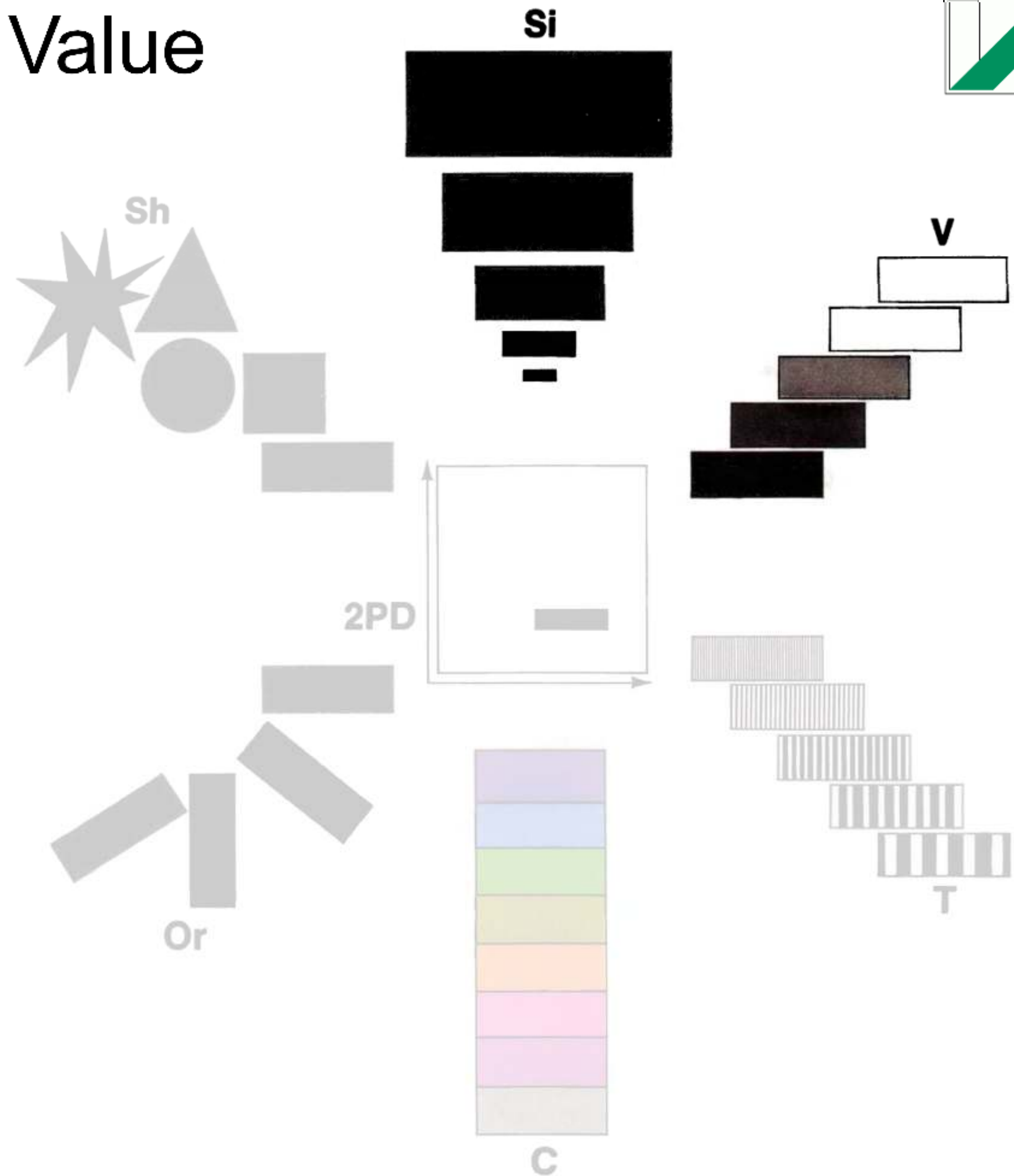

Graphical Elements: Shape & Texture

Great for showing

- Group membership

Texture can also be used to
encode different intensities/magnitudes

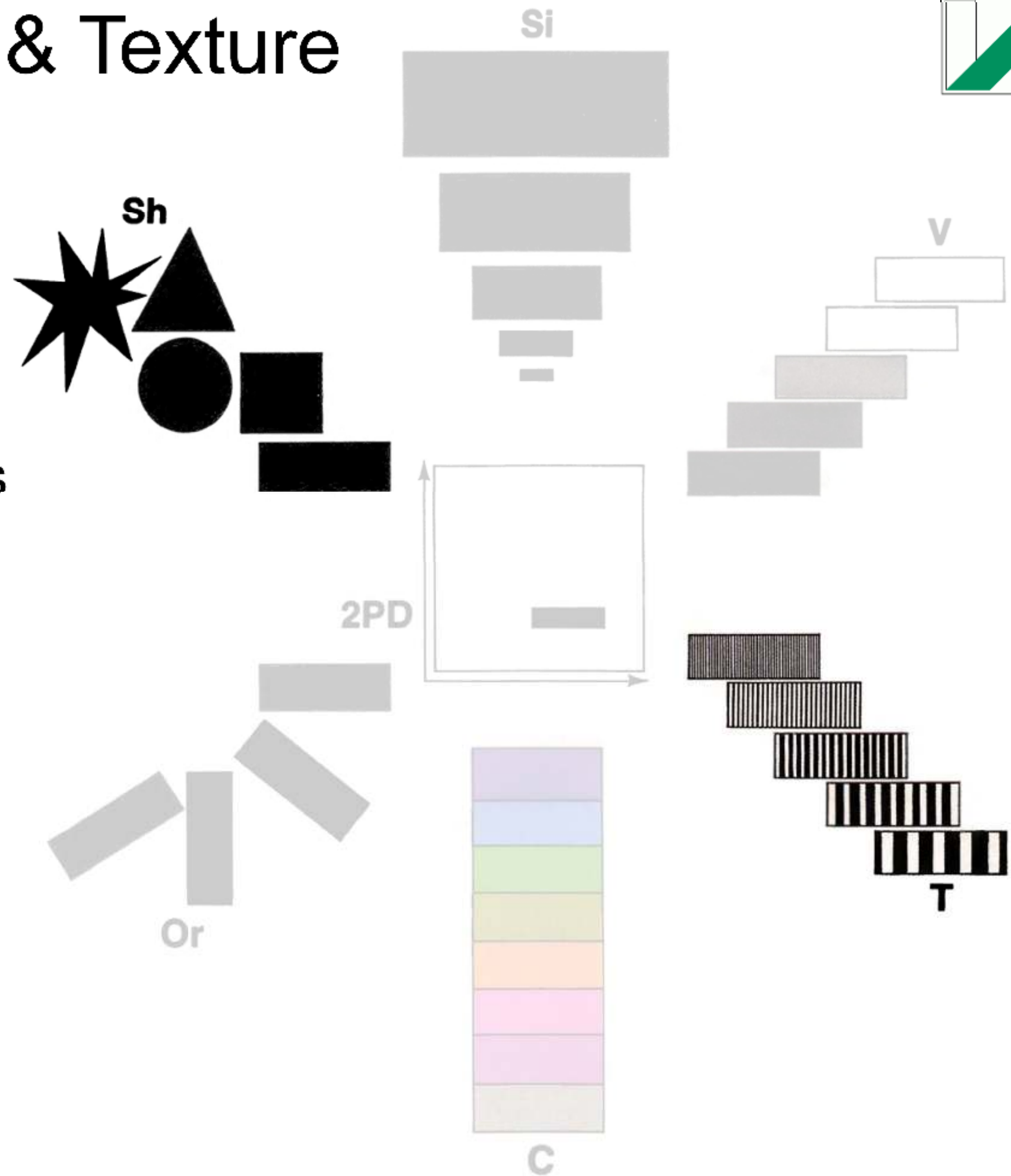

Graphical Elements: Orientation

Great for showing

- Movement
- Direction

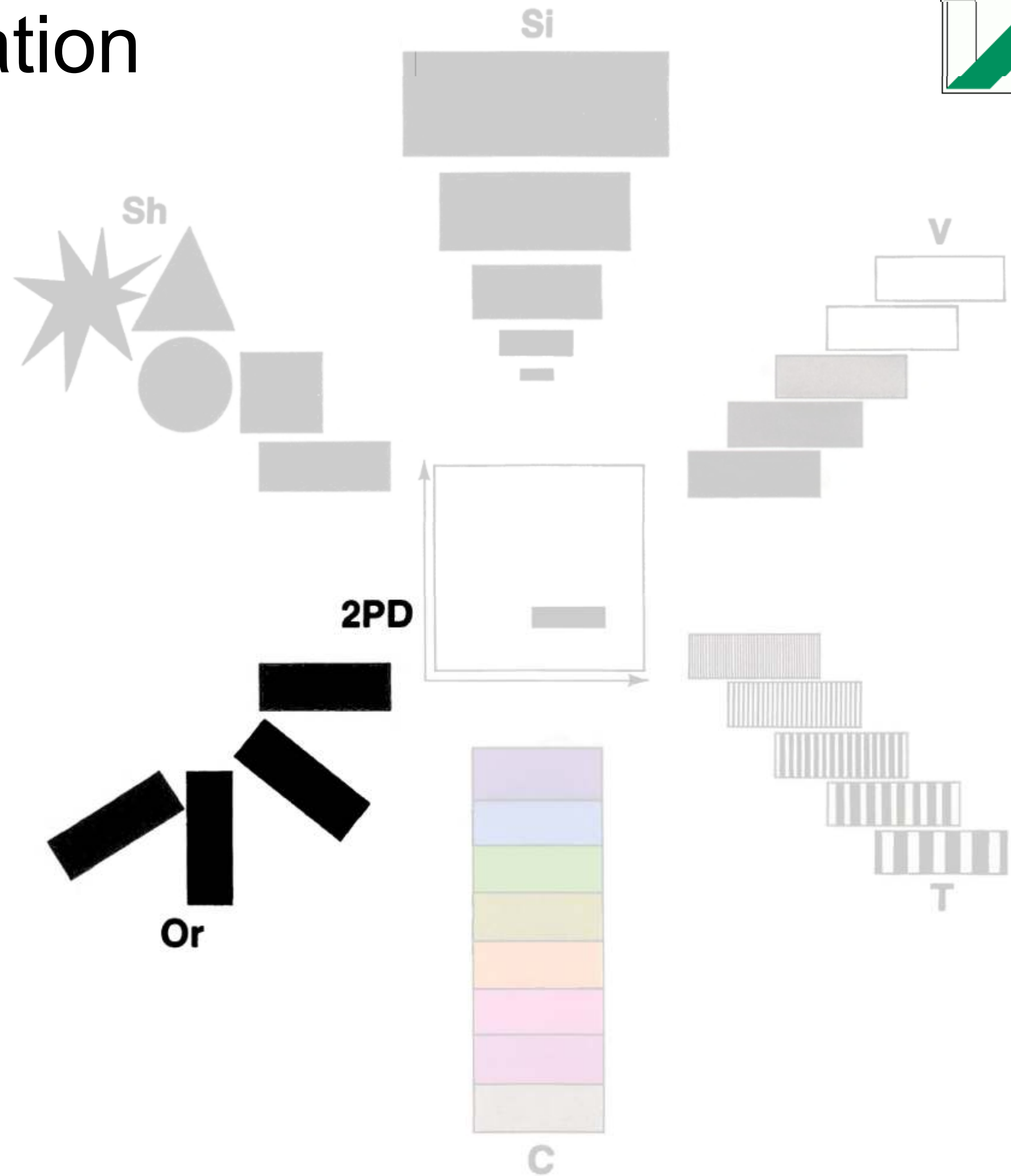

Graphical Elements: Color

Color has two dimensions:

- Hue
for group membership
- Saturation
encodes intensities / magnitudes

Always requires a legend!

May have unintended meaning

More on colors later

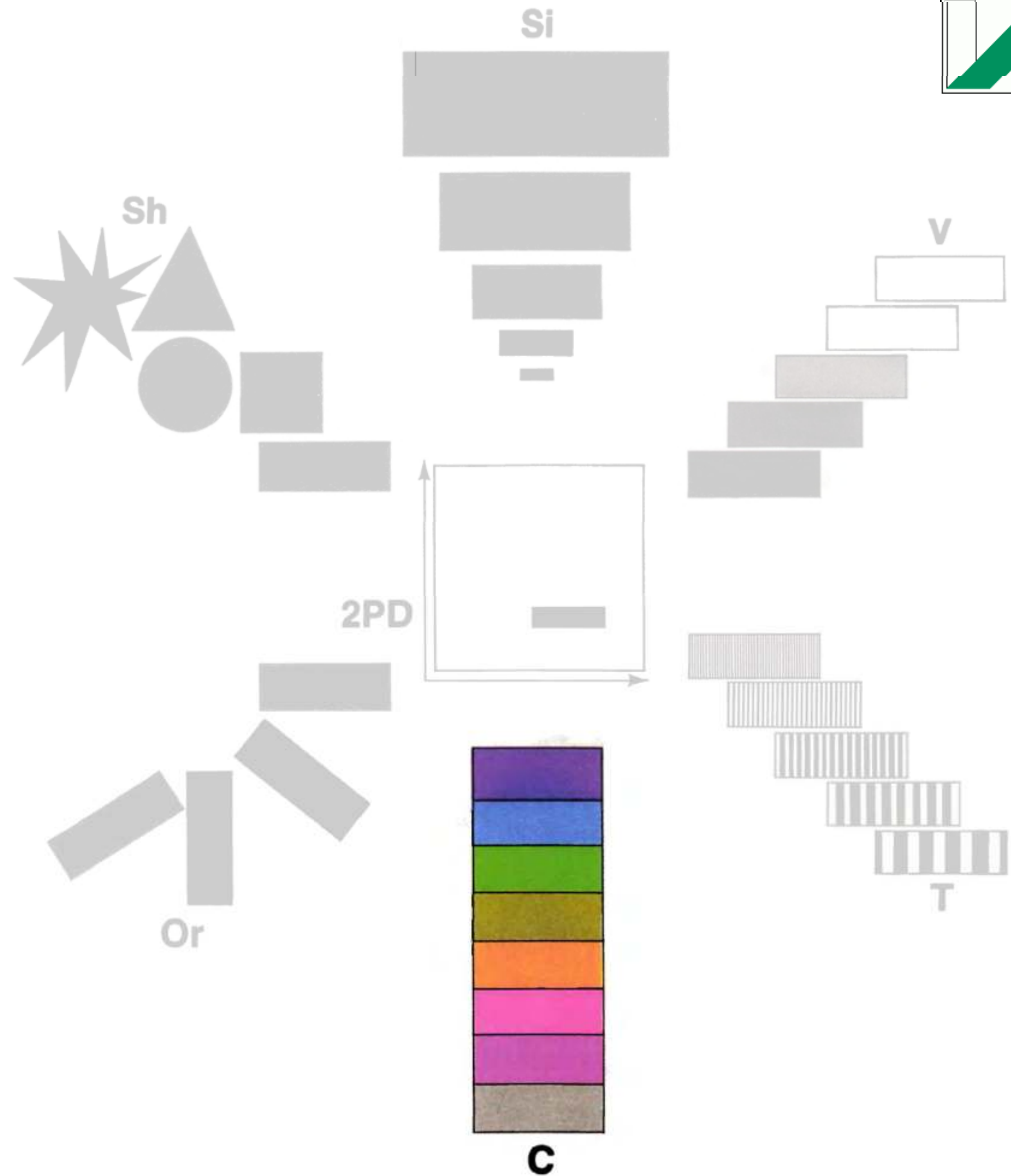

Graphical Elements: Position

Great for showing

- **Group membership**
elements in close distance belong together
- **Importance**
things above others are more important
- **Trends**
our brain interpolates between points and sees connections
- **Movement**

Very powerful design element!

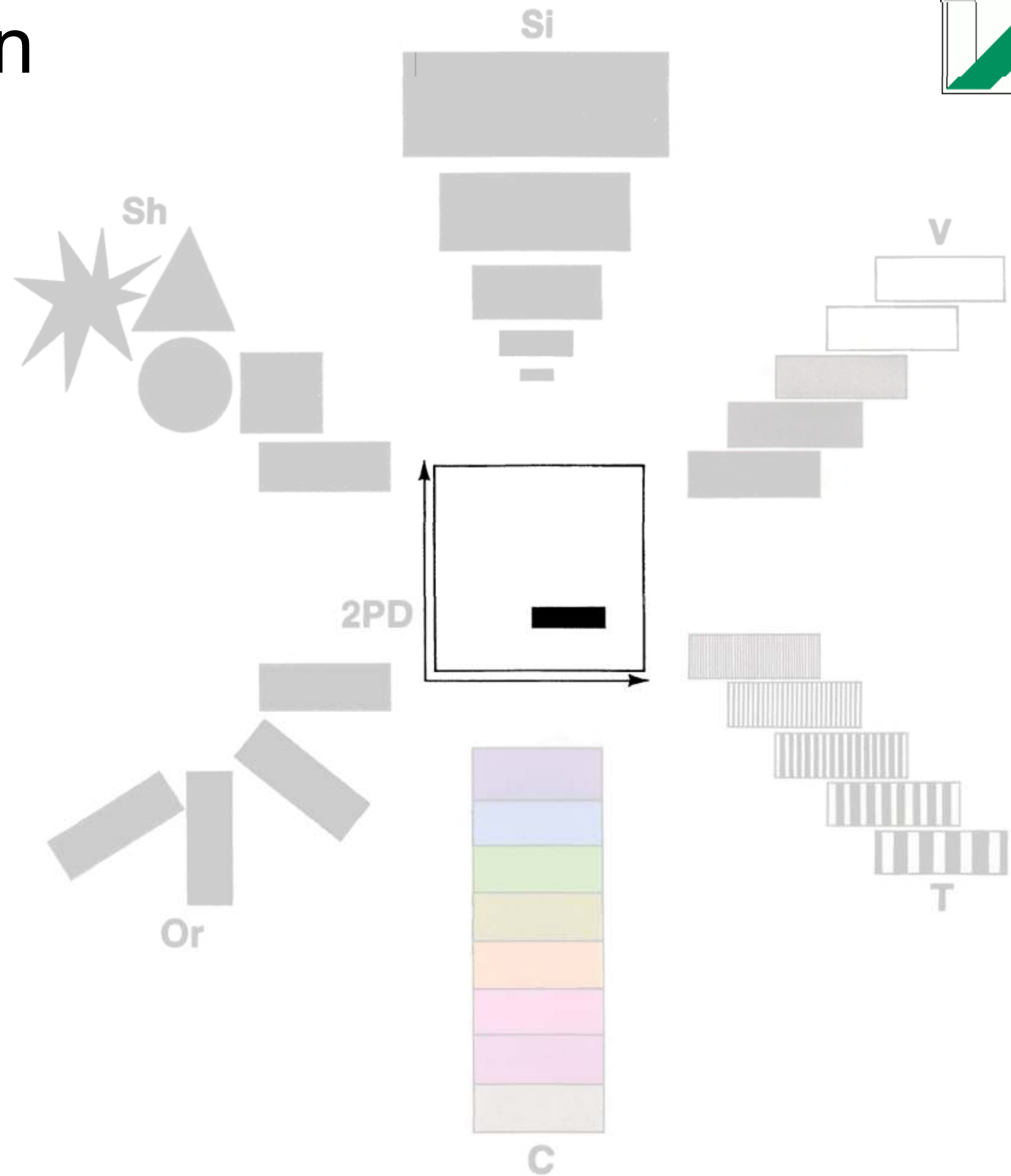

Perceived Grouping

Classical grouping by

b) Proximity

c) Color

d) Size

e) Common Fate

f) Good continuation

g) Closure

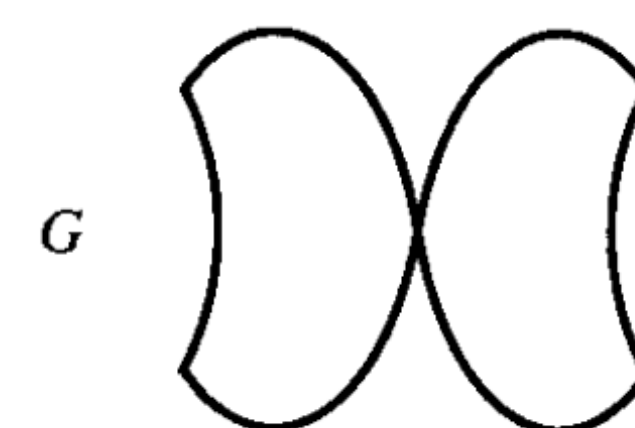
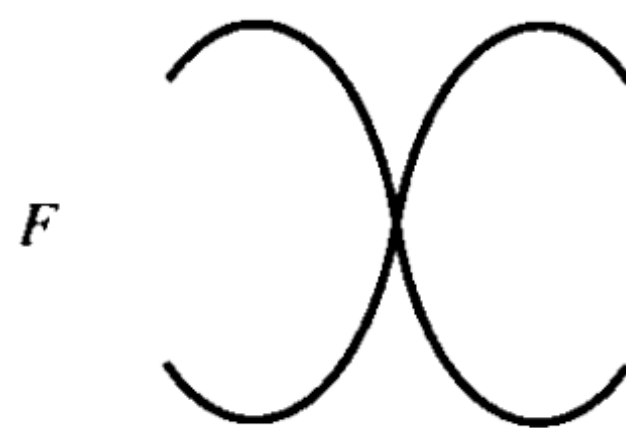



Gestalt Theory

Scientific efforts to understand pattern perception

Gestalt laws: set of robust rules describing how we see patterns

e.g. based on proximity, similarity, connectedness, continuity, symmetry, closure, relative size, and common fate

Often translated into design principles for information visualization

Use these elements to think about how to organize data so that important structures will be perceived

„If we can map information structures to readily perceived patterns, then those structures will be more easily interpreted.“

Proximity



Proximity

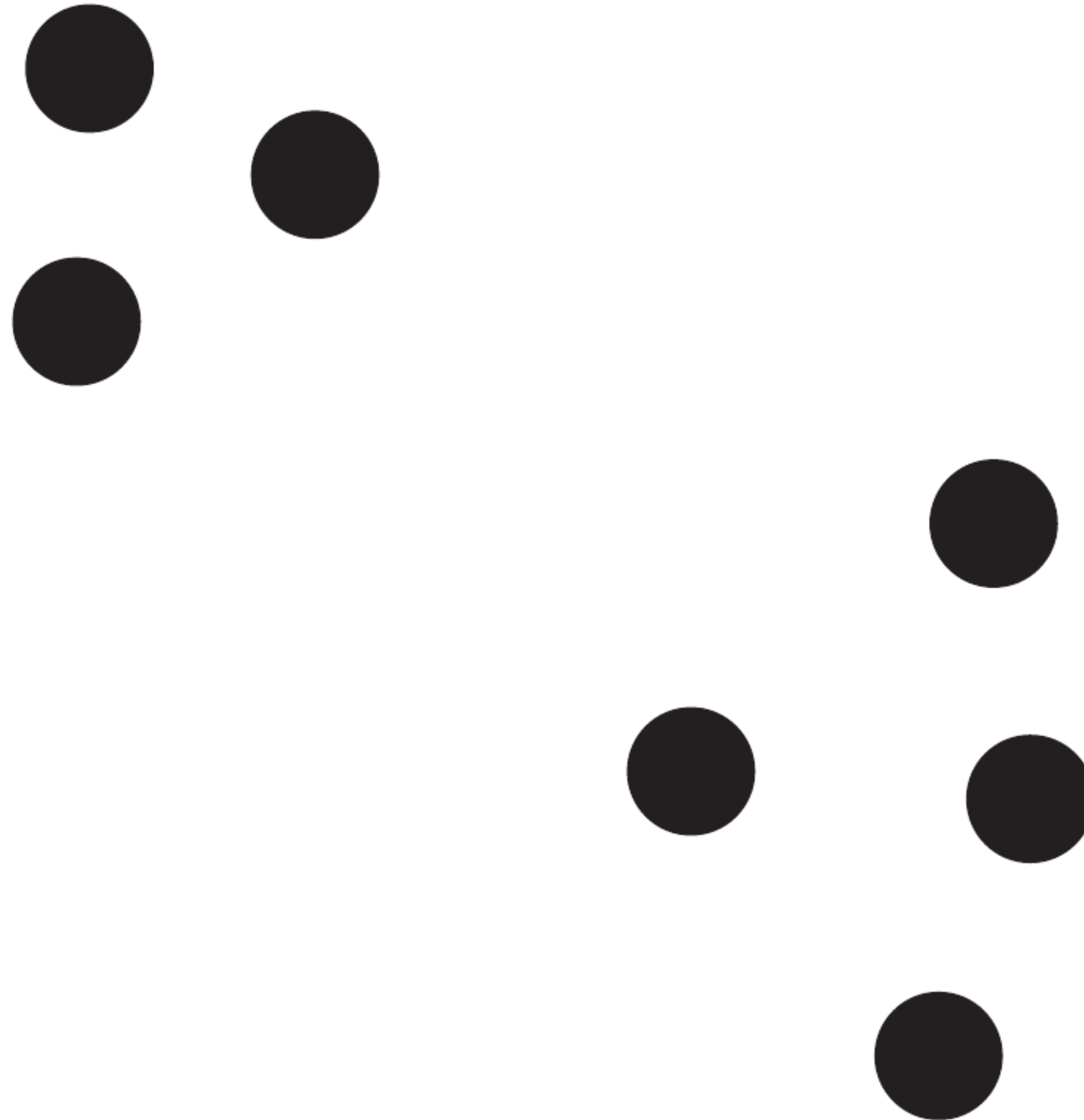

Spatial Concentration

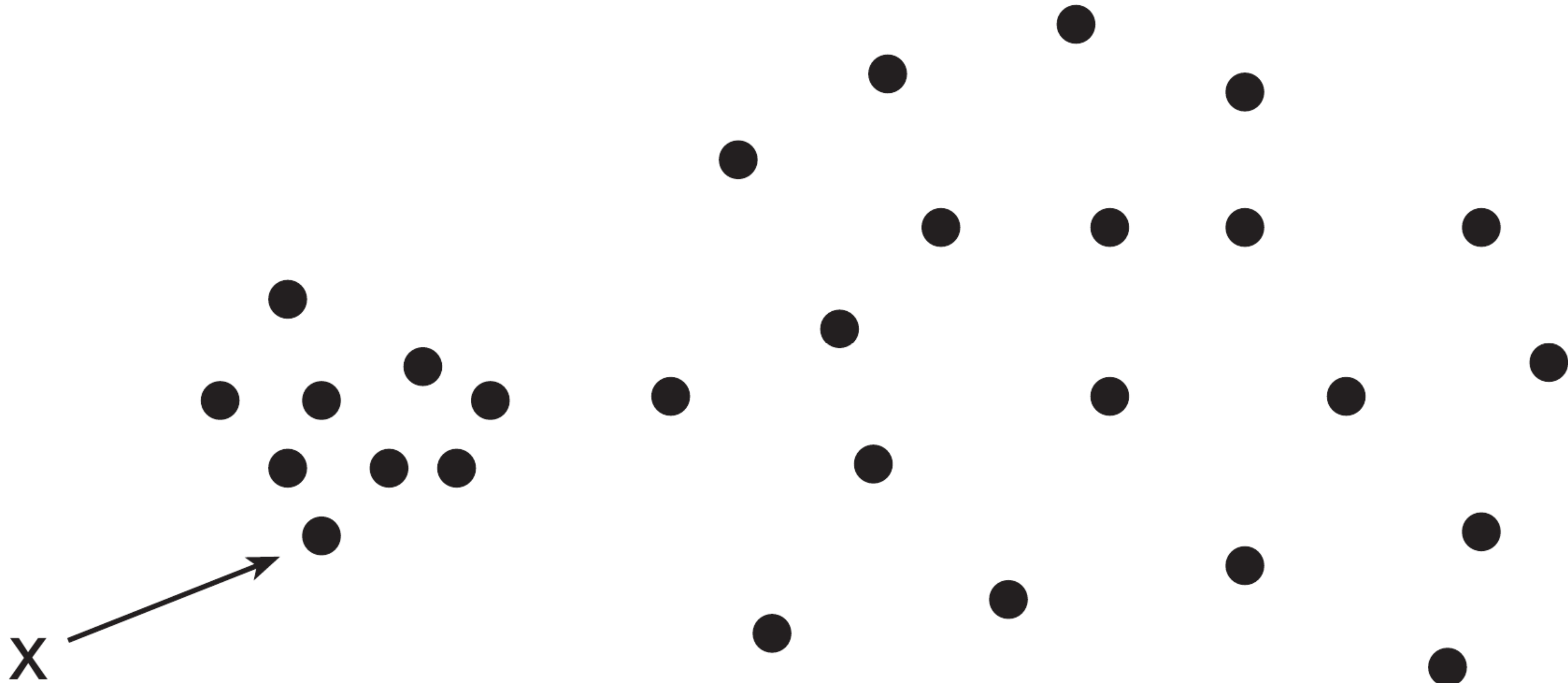

Shape

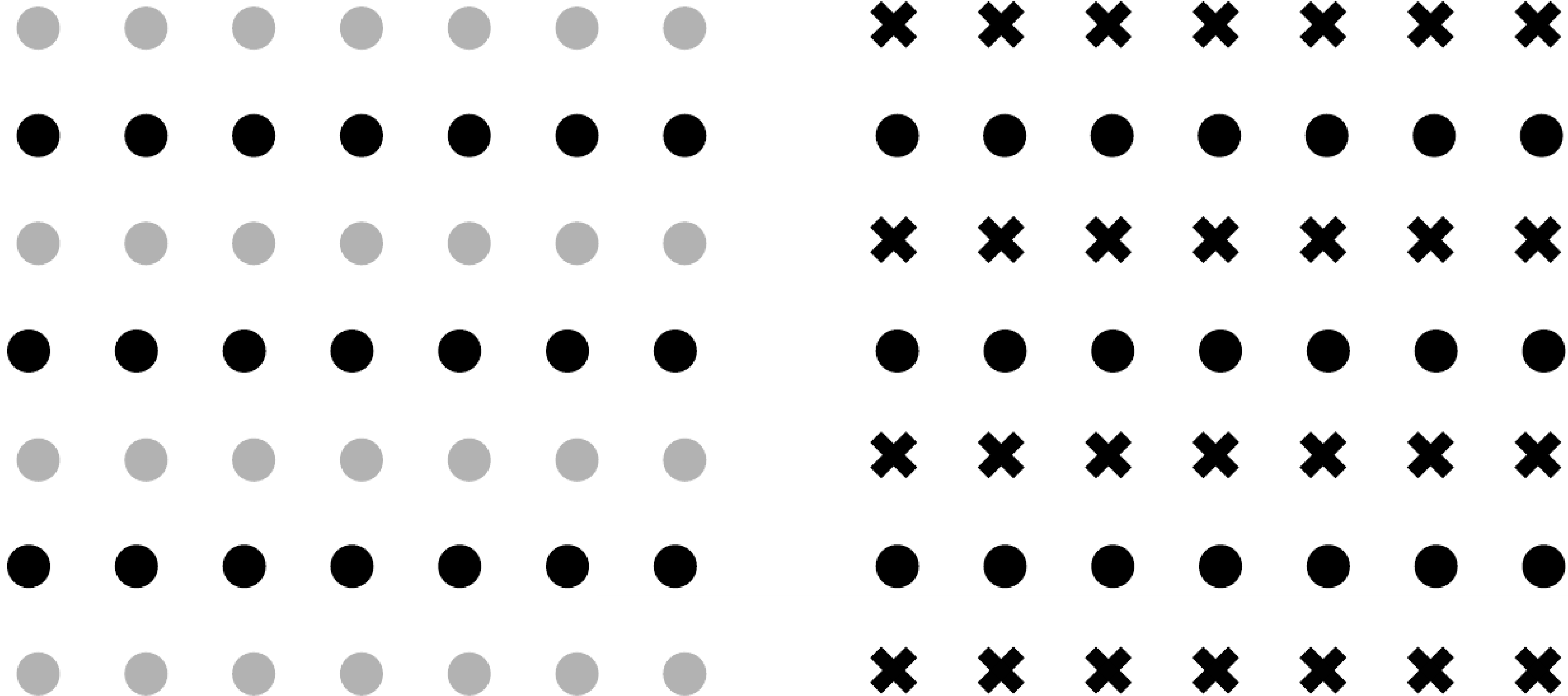

Connectedness

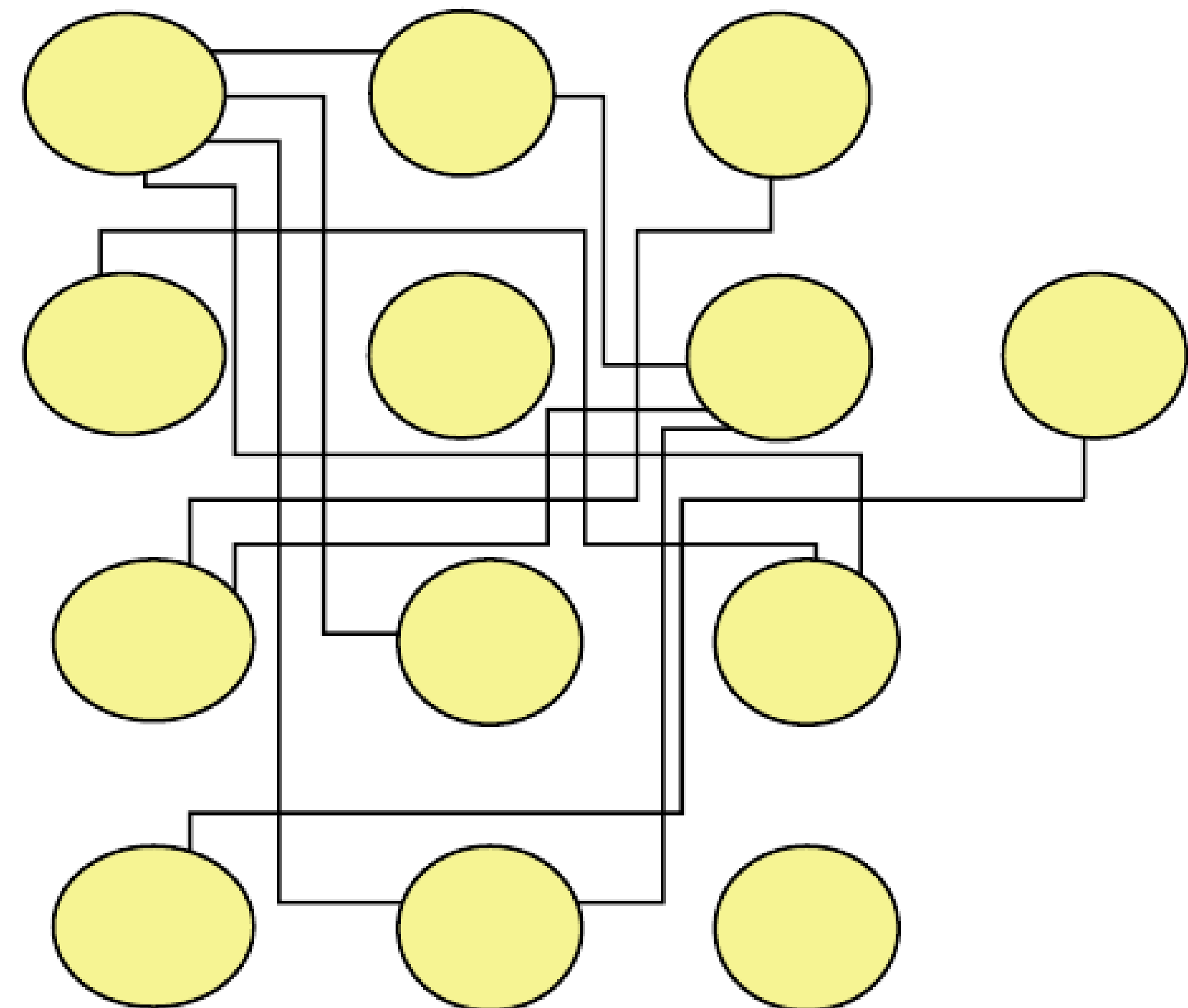
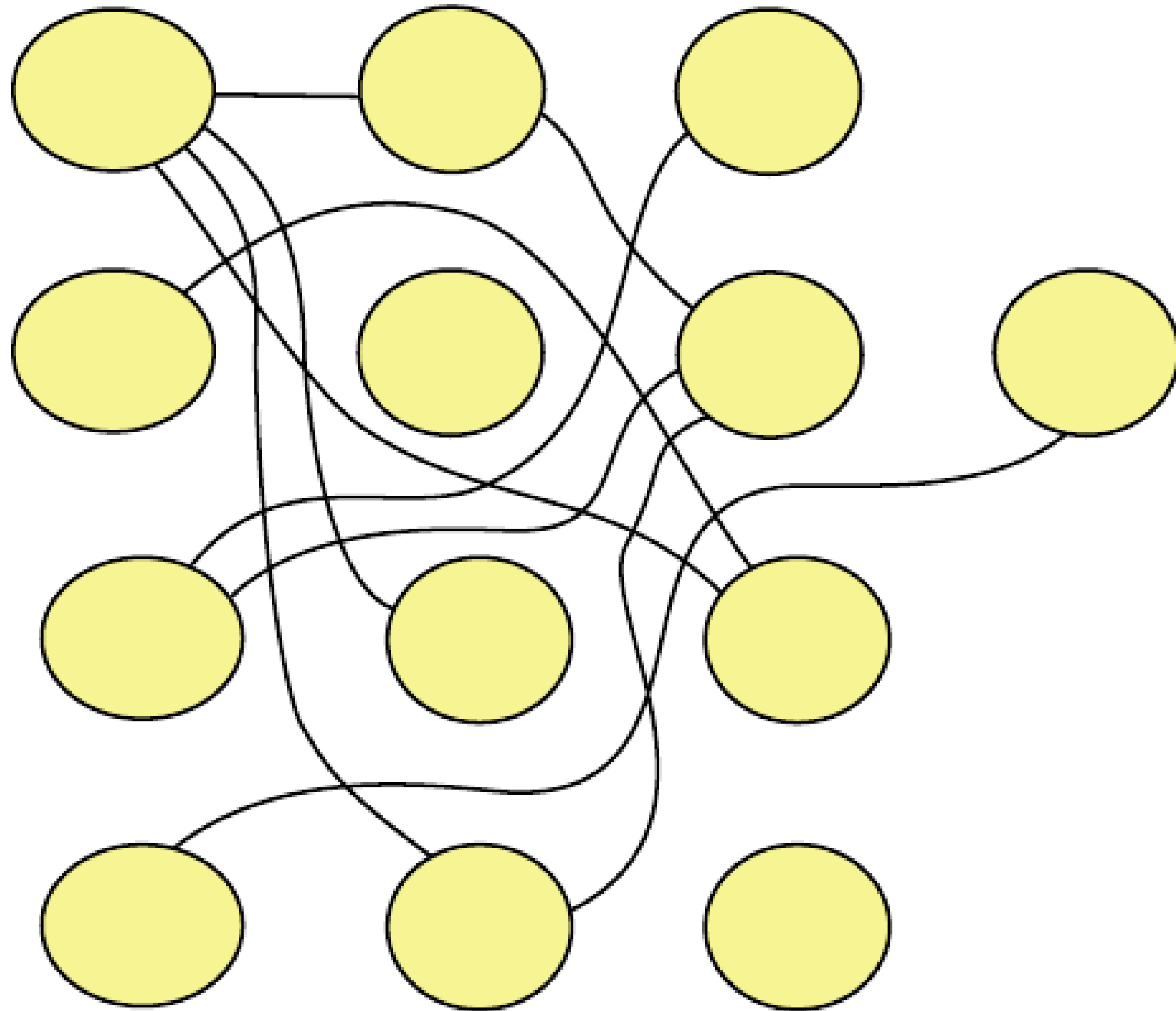

Uniform Connectedness

Principle of perceptual organization

Connectedness can „overwrite“ classical grouping factors proximity, color, size, shape

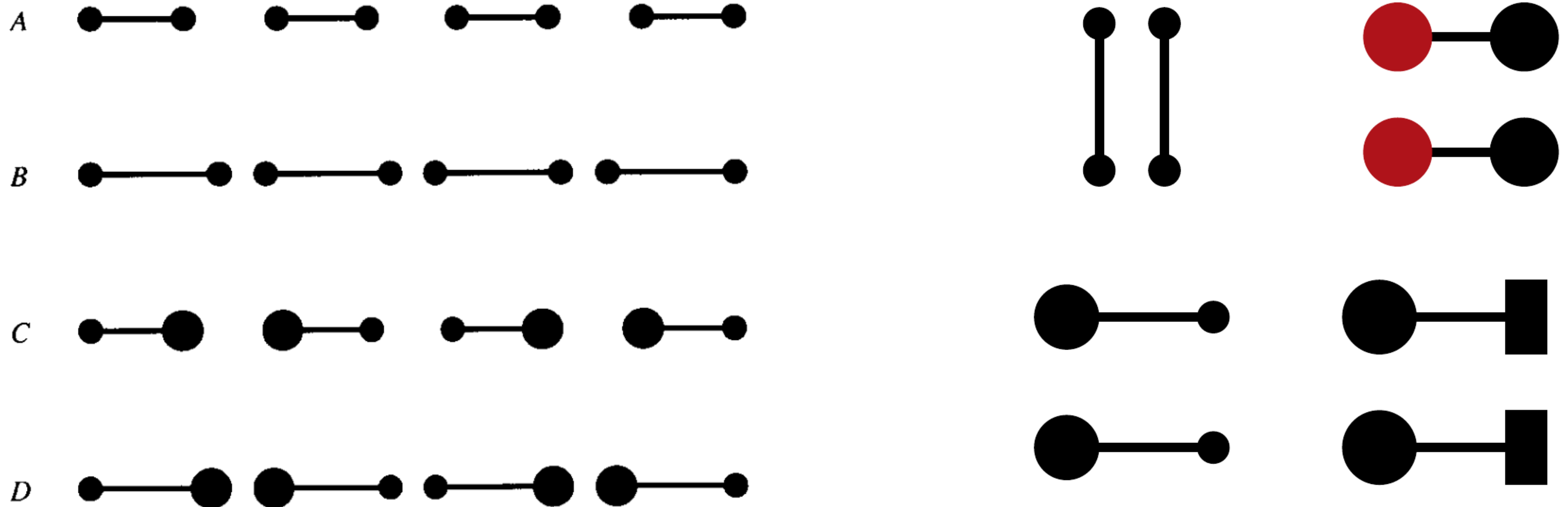

Different Graphical Elements for Different Types of Data

Encoding Quantitative Information

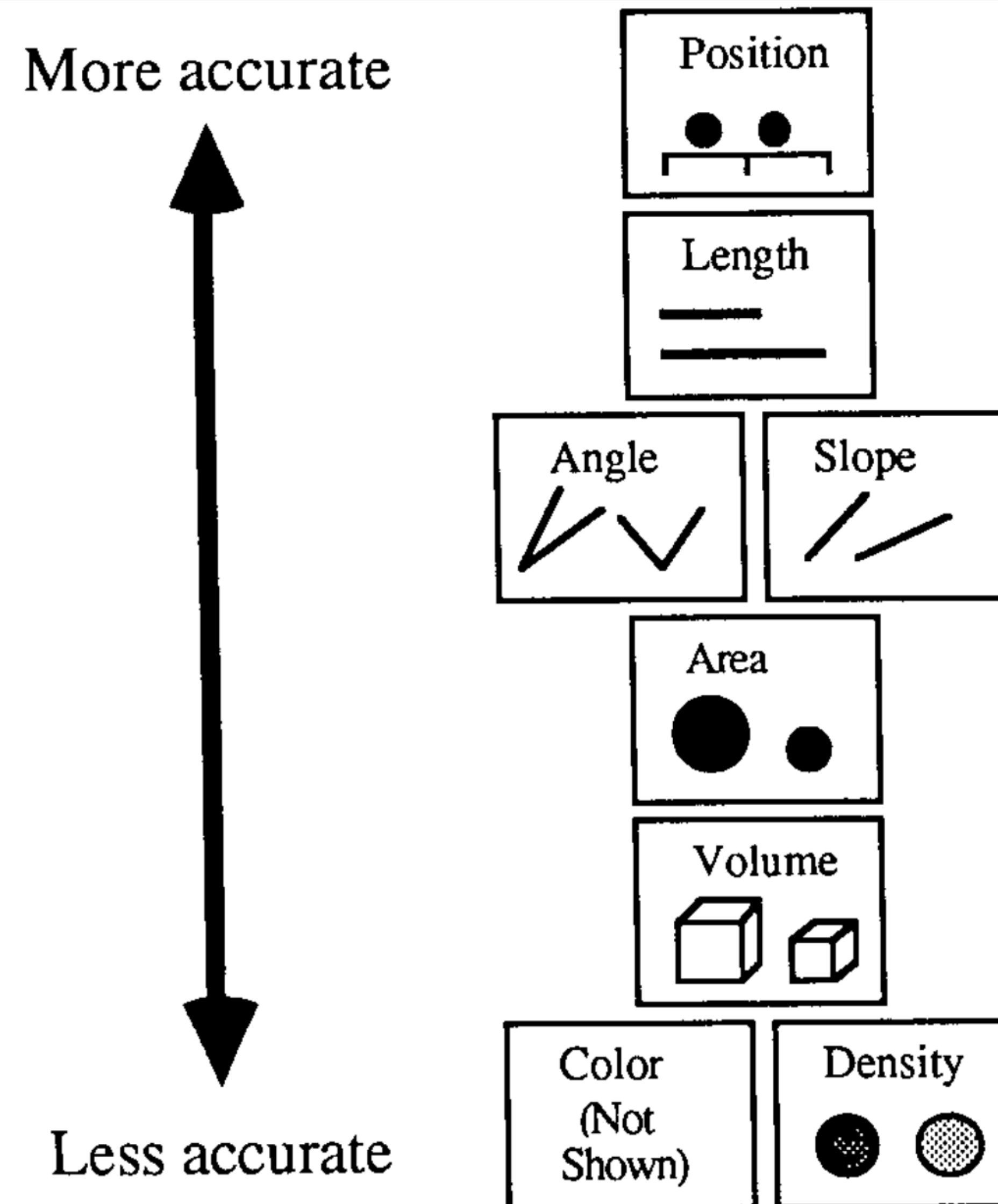

Encoding Data Types

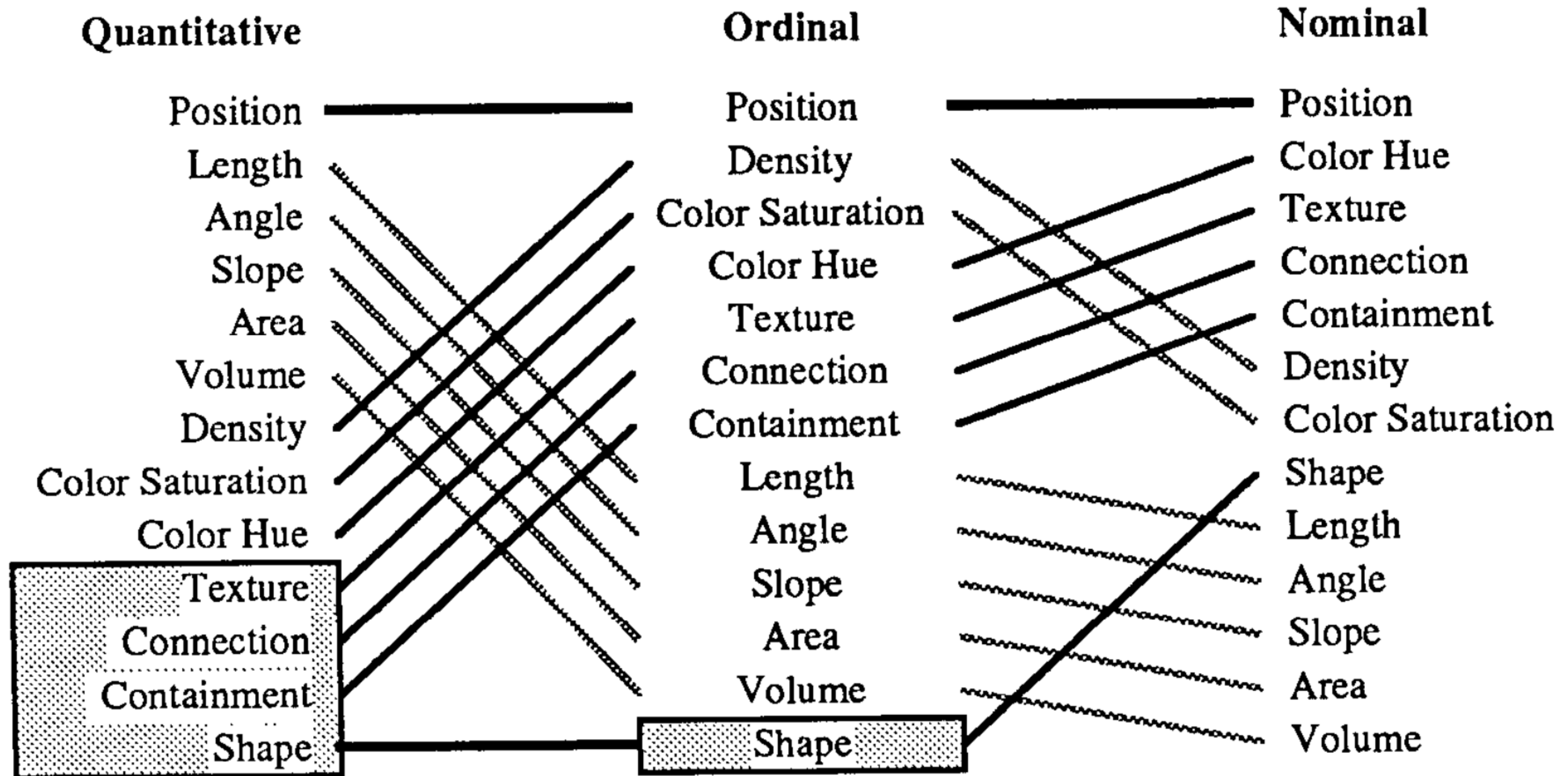

Encoding Data Types

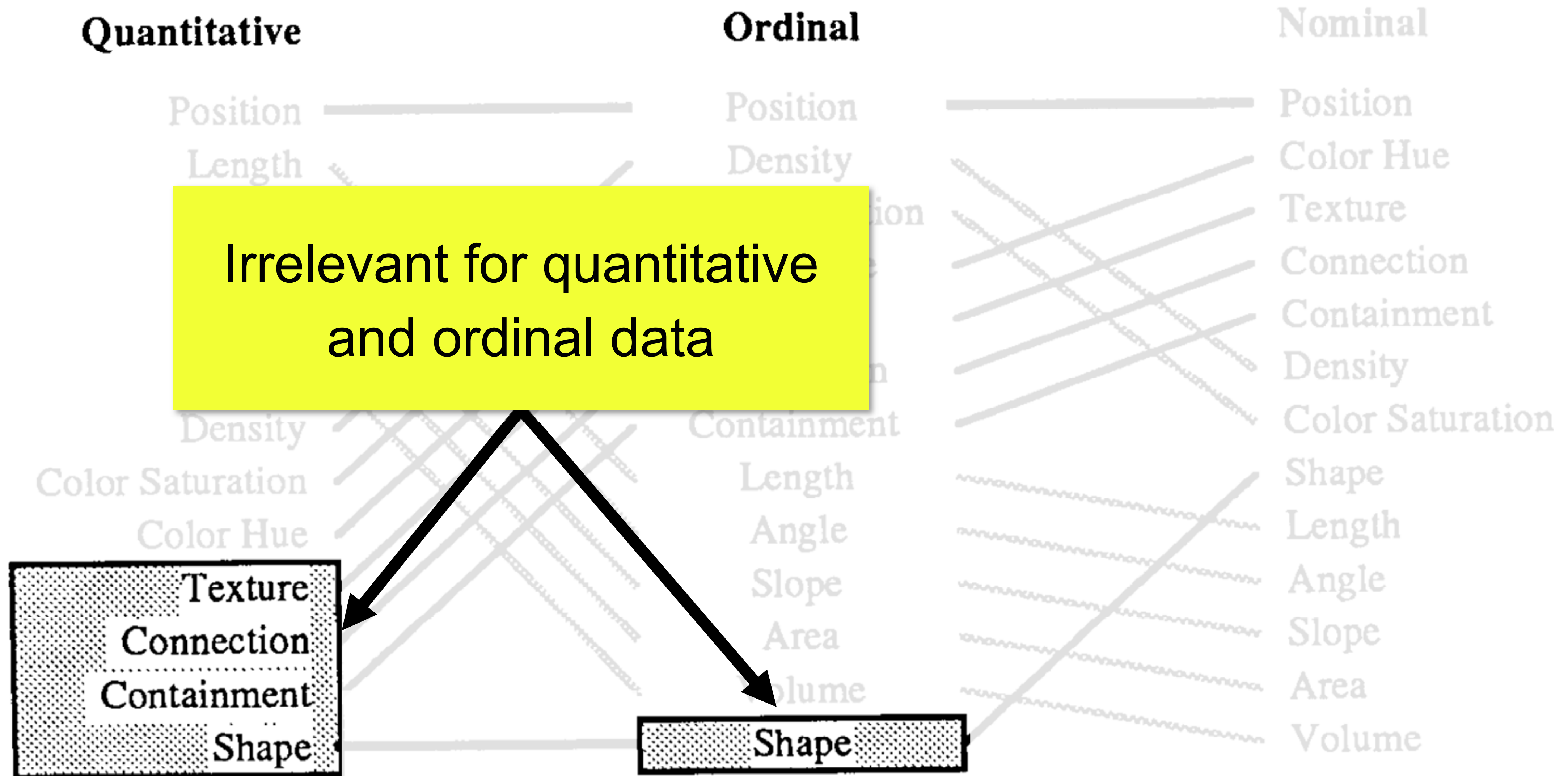

Encoding Data Types

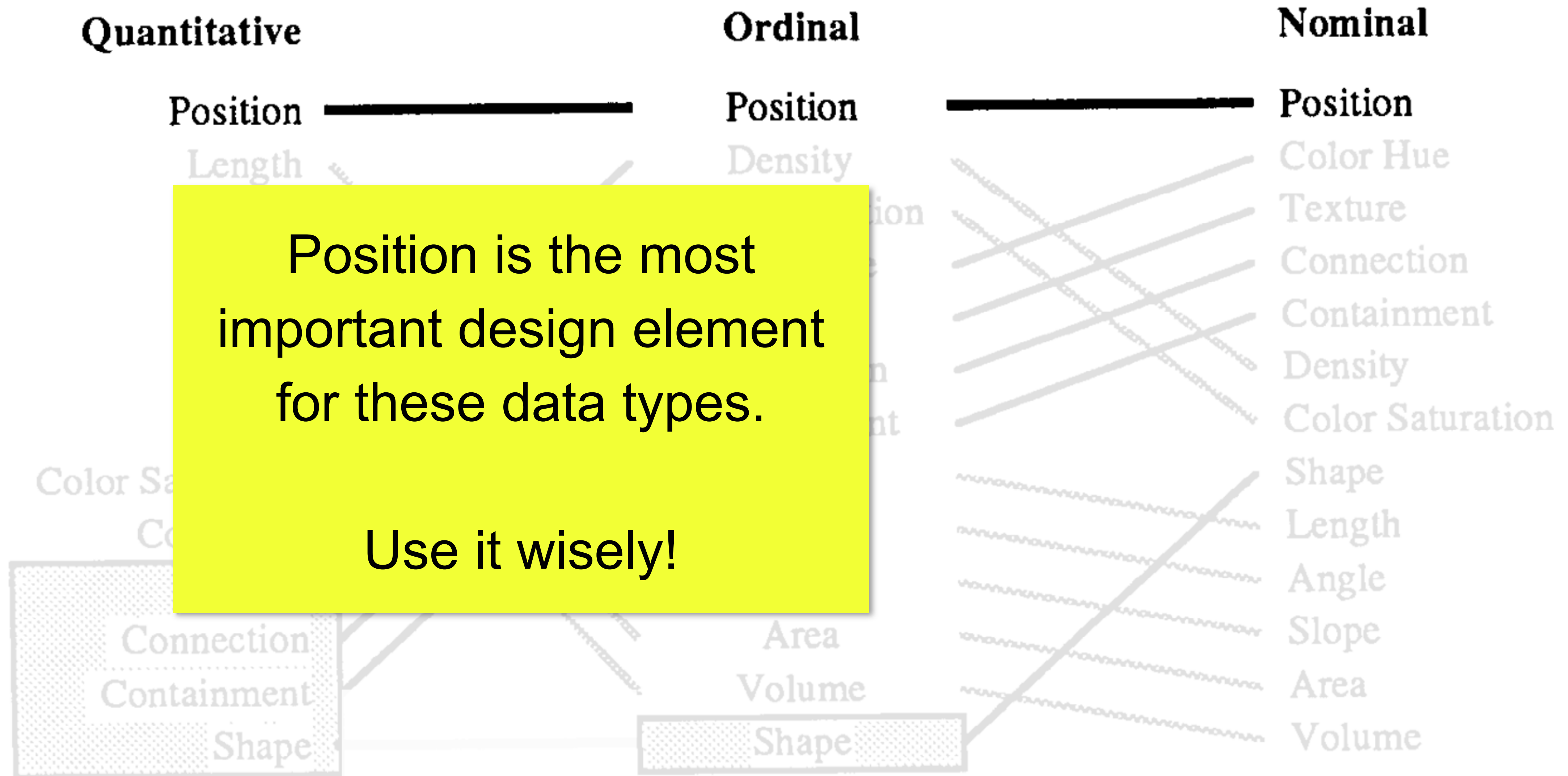

Effectiveness of Using a Shapes' Area

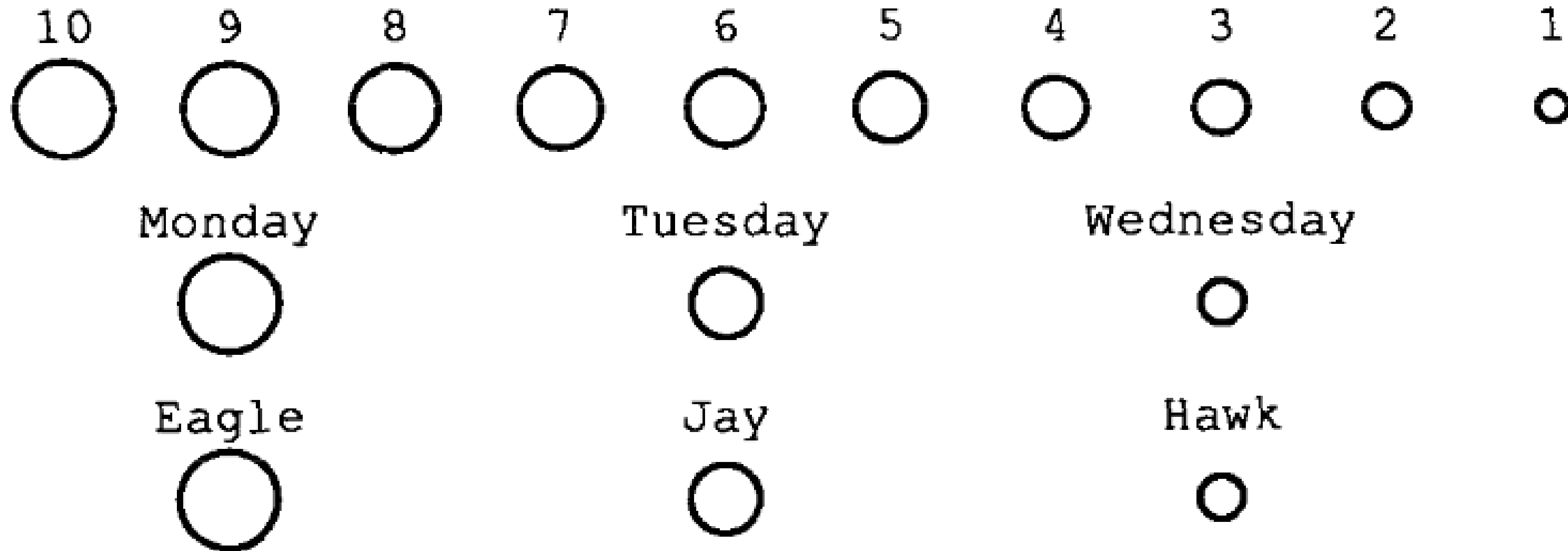

Quantitative information:
shows order among elements;
misjudgements expected if laid out
randomly

Ordinal information
make sure to vary sizes
enough

Nominal information
group assignments are visible;
step sizes are an issue;
order is perceived

Beware of the Scaling Problem When Using Area

Perceived and actual magnitude differ

Psychophysical power law

$$\psi = k\phi^\beta$$

- ψ Sensation magnitude
- ϕ Stimulus magnitude
- k mostly irrelevant constant
- β signature of a sensory continuum

Continuum	Measured Exponent (β)	Doubled Stimulus (2^β)	Stimulus Condition
Visual length	1.0	2.0	Projected line
Visual area	0.7	1.6	Projected square
Redness (saturation)	1.7	3.2	Red-gray mixture
Loudness	0.67	1.6	Sound pressure of 3000Hz tone
Lightness	1.2	2.3	Reflectance of gray papers
Cold	1	2.0	Metal contact on arm
Warmth	1.6	3.0	Metal contact on arm
Taste	1.4	2.6	Salt
Taste	0.8	1.7	Saccharine
...			

Perceived and Actual Magnitude



Perceived magnitude of area: 1.60
Actual magnitude of area: 2.00



Perceived magnitude of area: 2.00
Actual magnitude of area: 2.69

Graphical Integrity

People are 178% worried

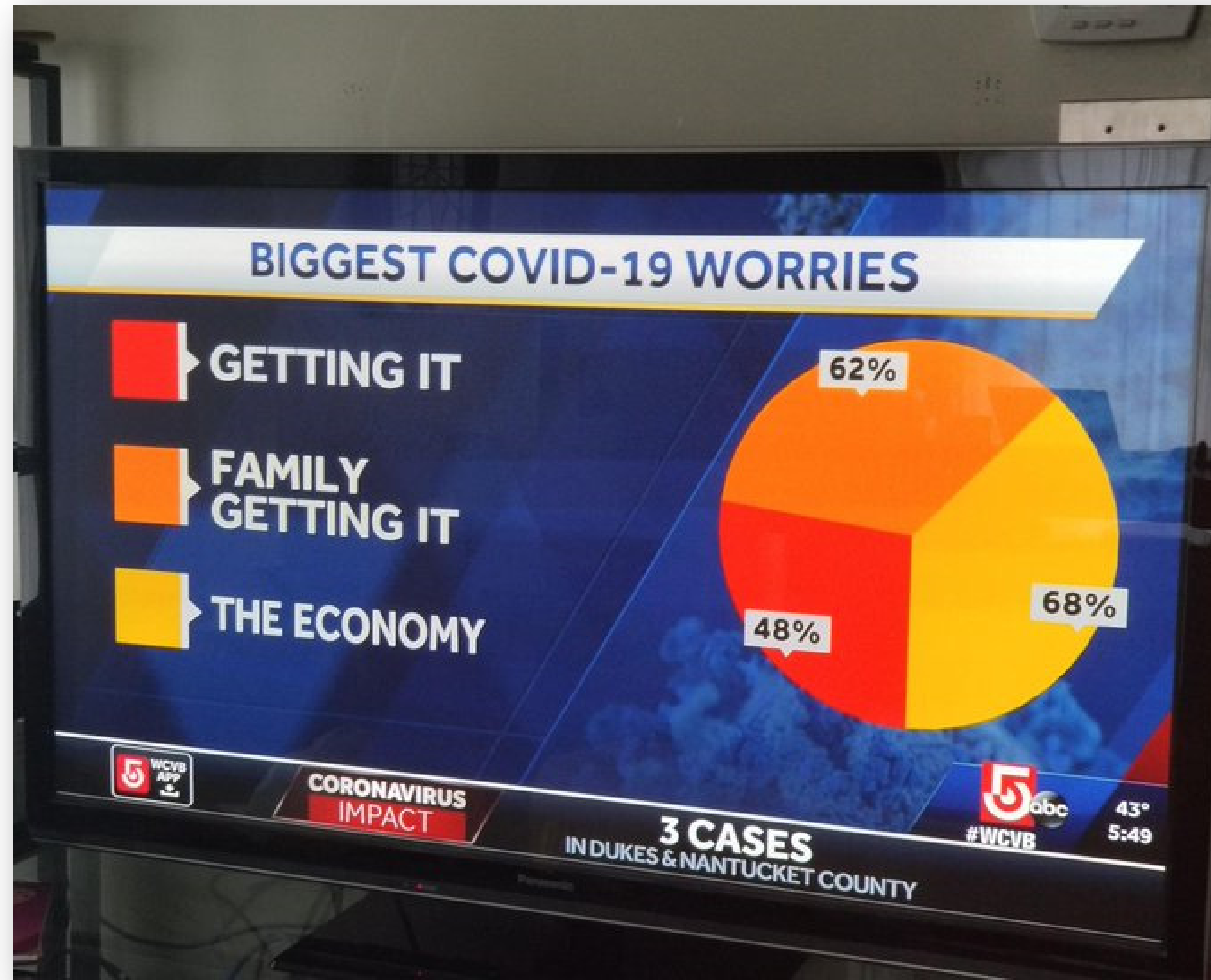

Trust only the statistics that you have falsified yourself



Assume these sales figures:

100 101 100,5 102 101,5 103 102,5 101,5 103 105

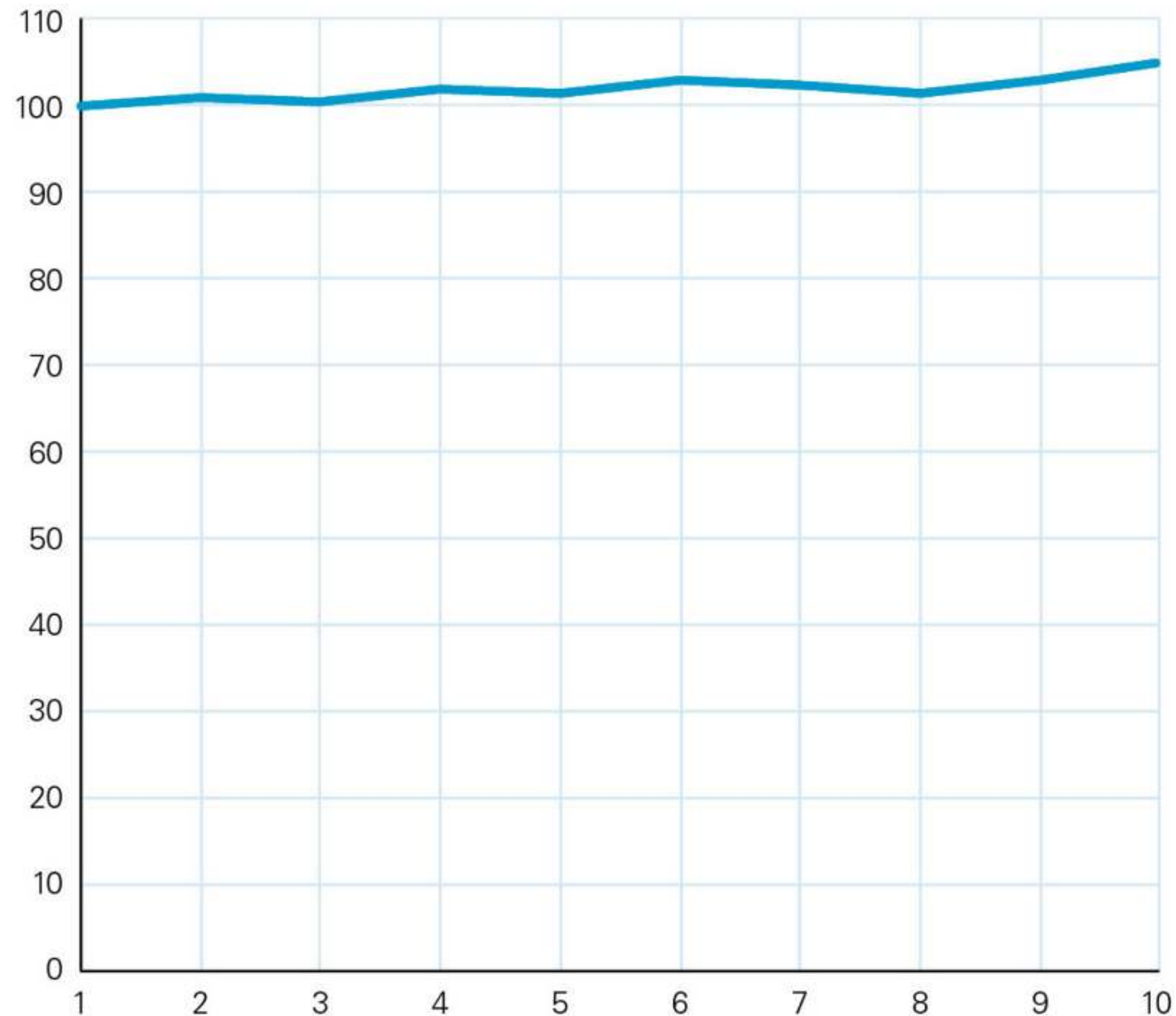

Trust only the statistics that you have falsified yourself



Assume these sales figures:

100 101 100,5 102 101,5 103 102,5 101,5 103 105

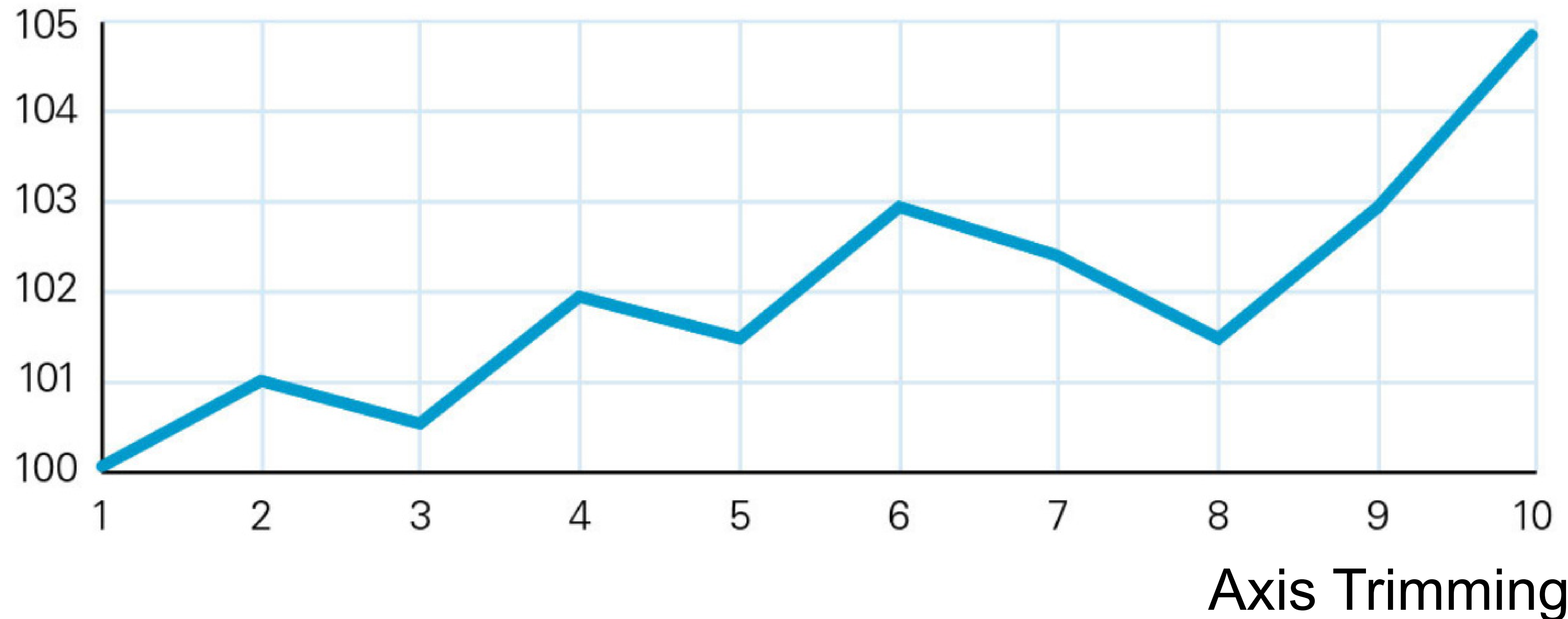

Trust only the statistics that you have falsified yourself



Assume these sales figures:

100 101 100,5 102 101,5 103 102,5 101,5 103 105

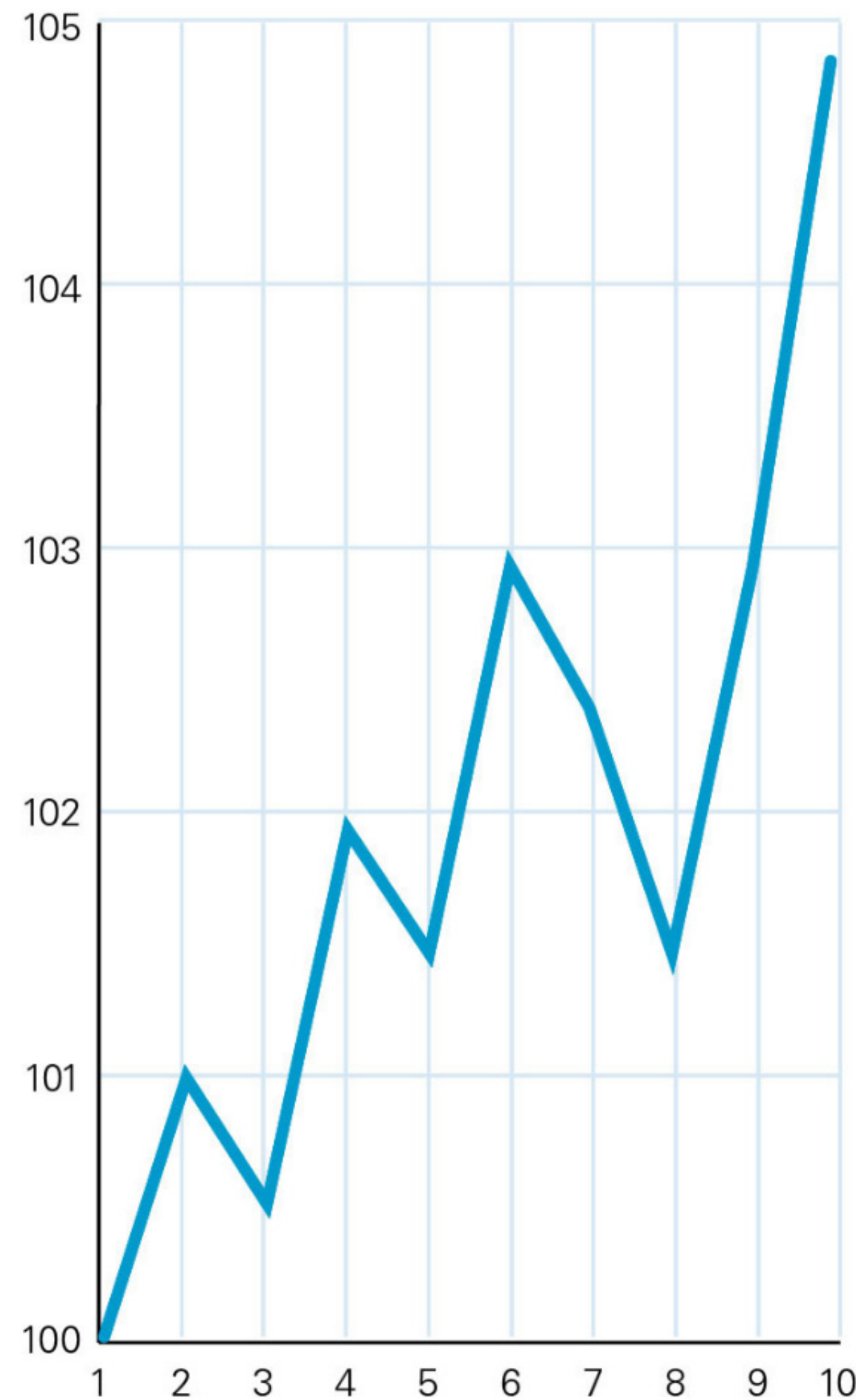

Axis Expansion /
Compression

Trust only the statistics that you have falsified yourself



Assume these sales figures:

100 101 100,5 102 101,5 103 102,5 101,5 103 105

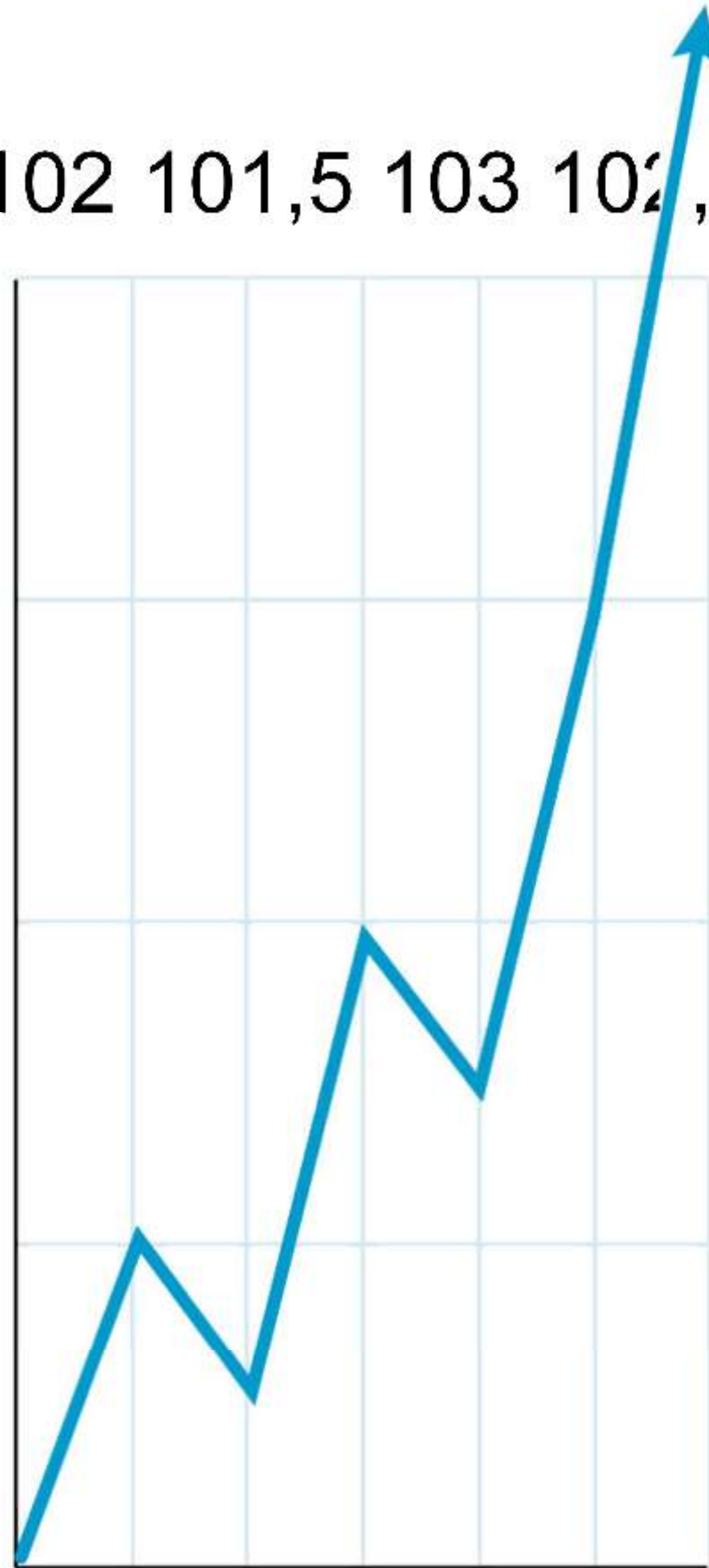

Remove Labels

Trust only the statistics that you have falsified yourself

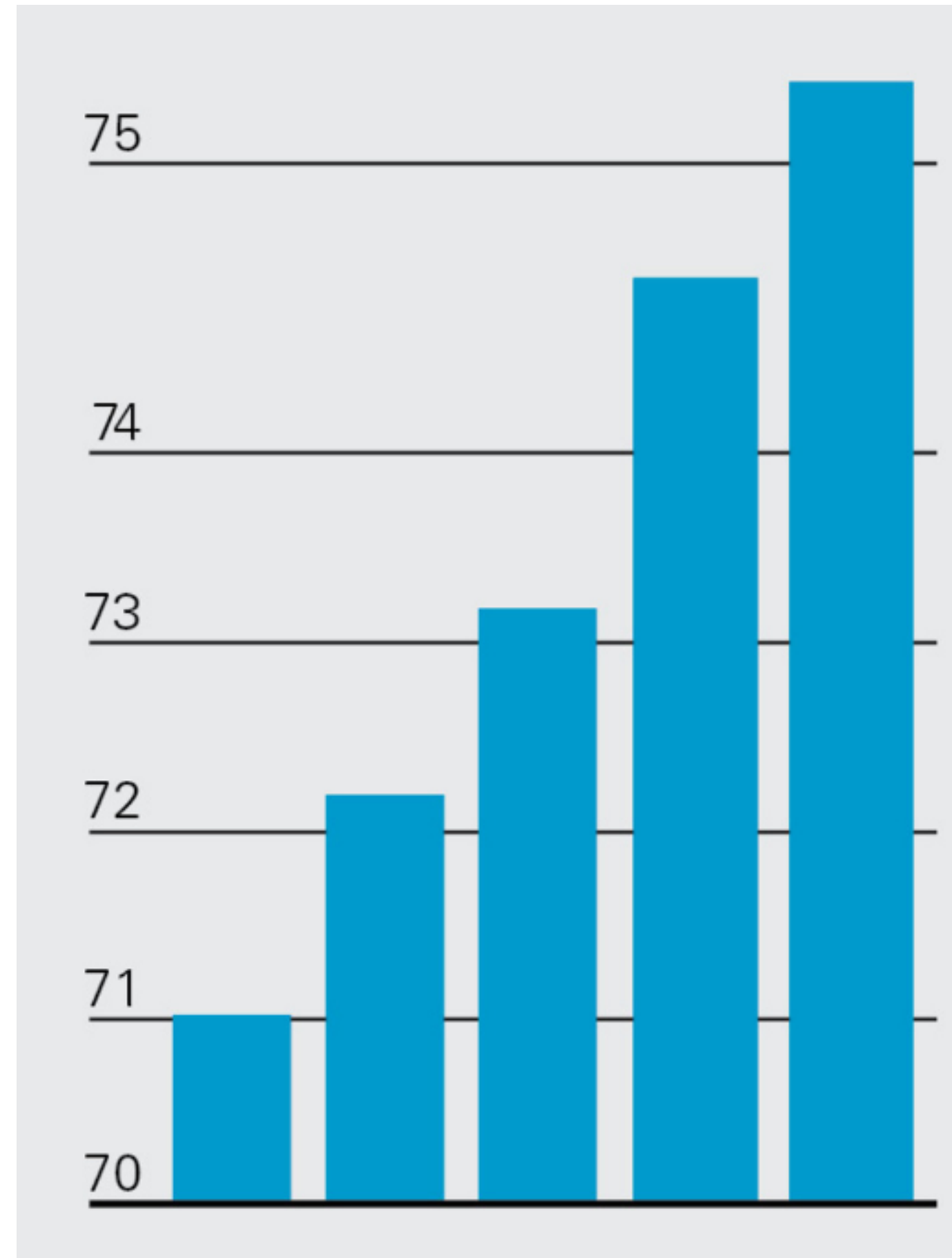
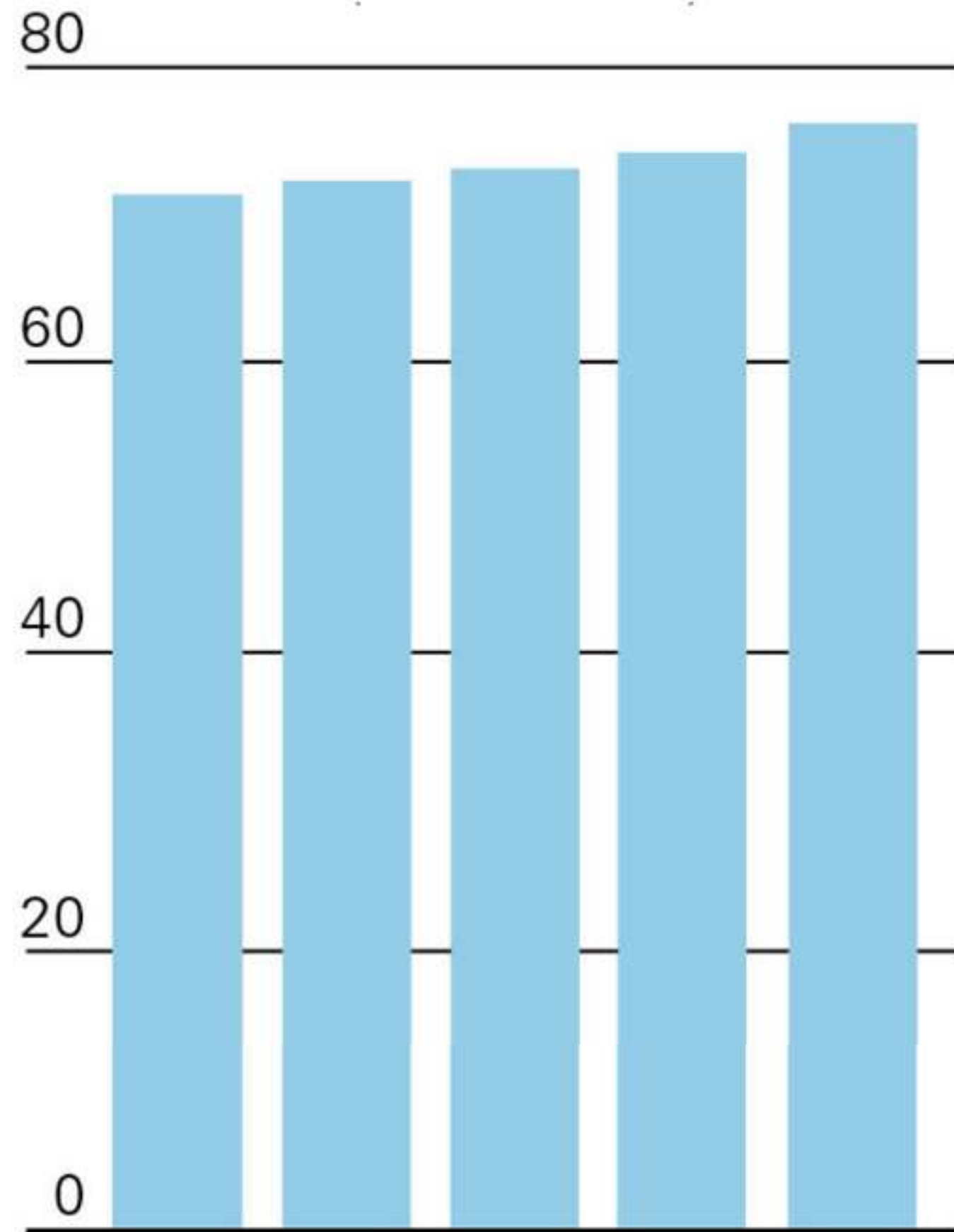

Trimming of Axis

Trust only the statistics that you have falsified yourself

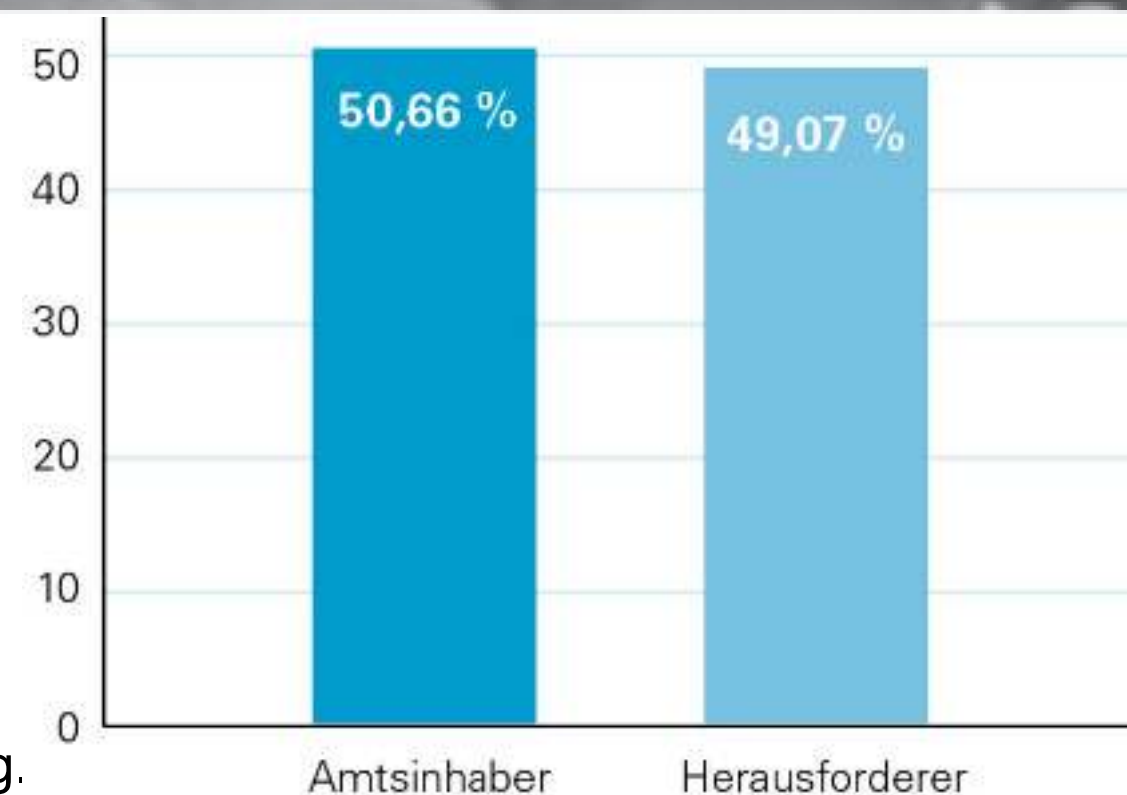

A Venezualian election

Trimming of Axis

Trust only the statistics that you have falsified yourself

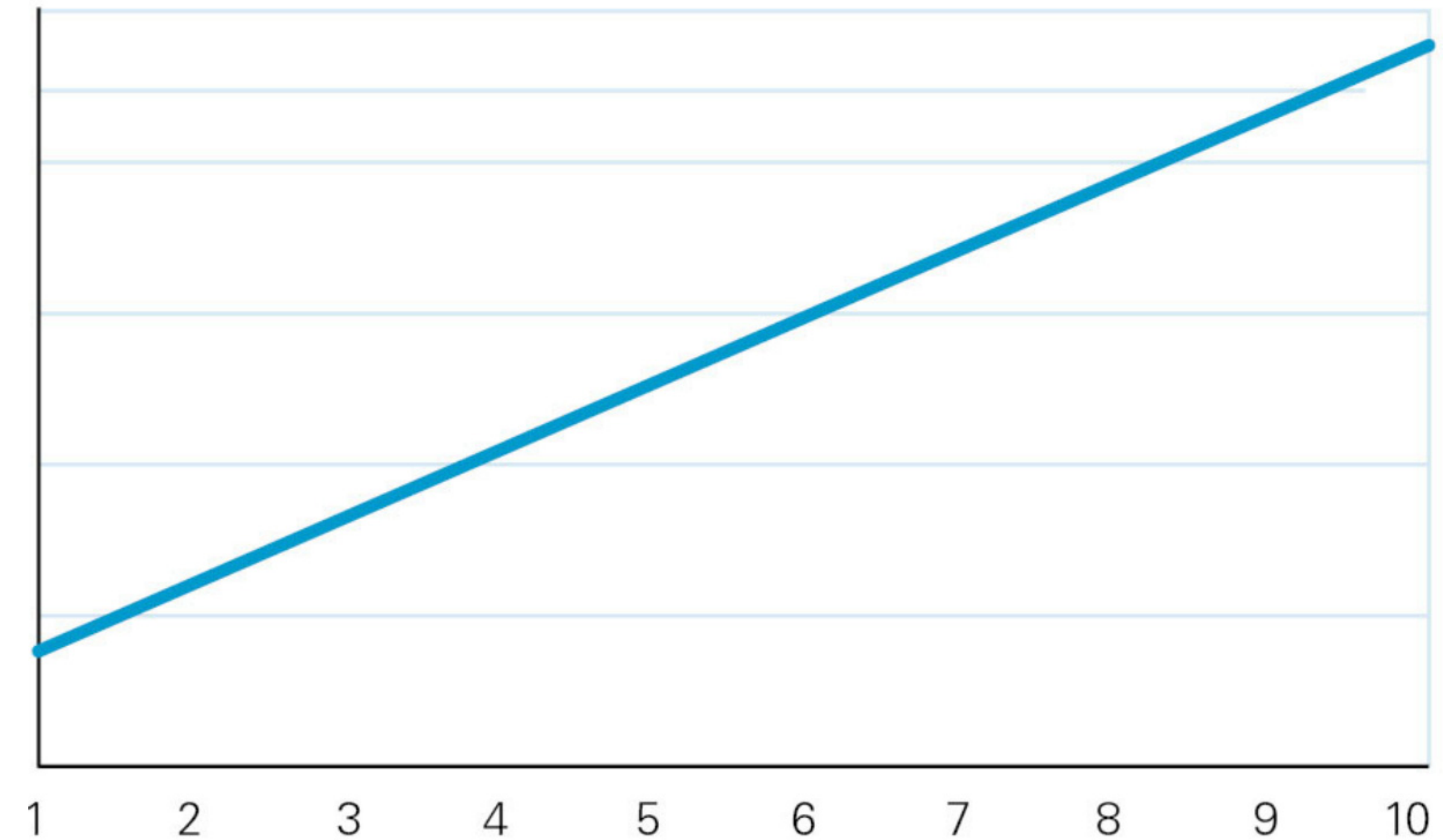
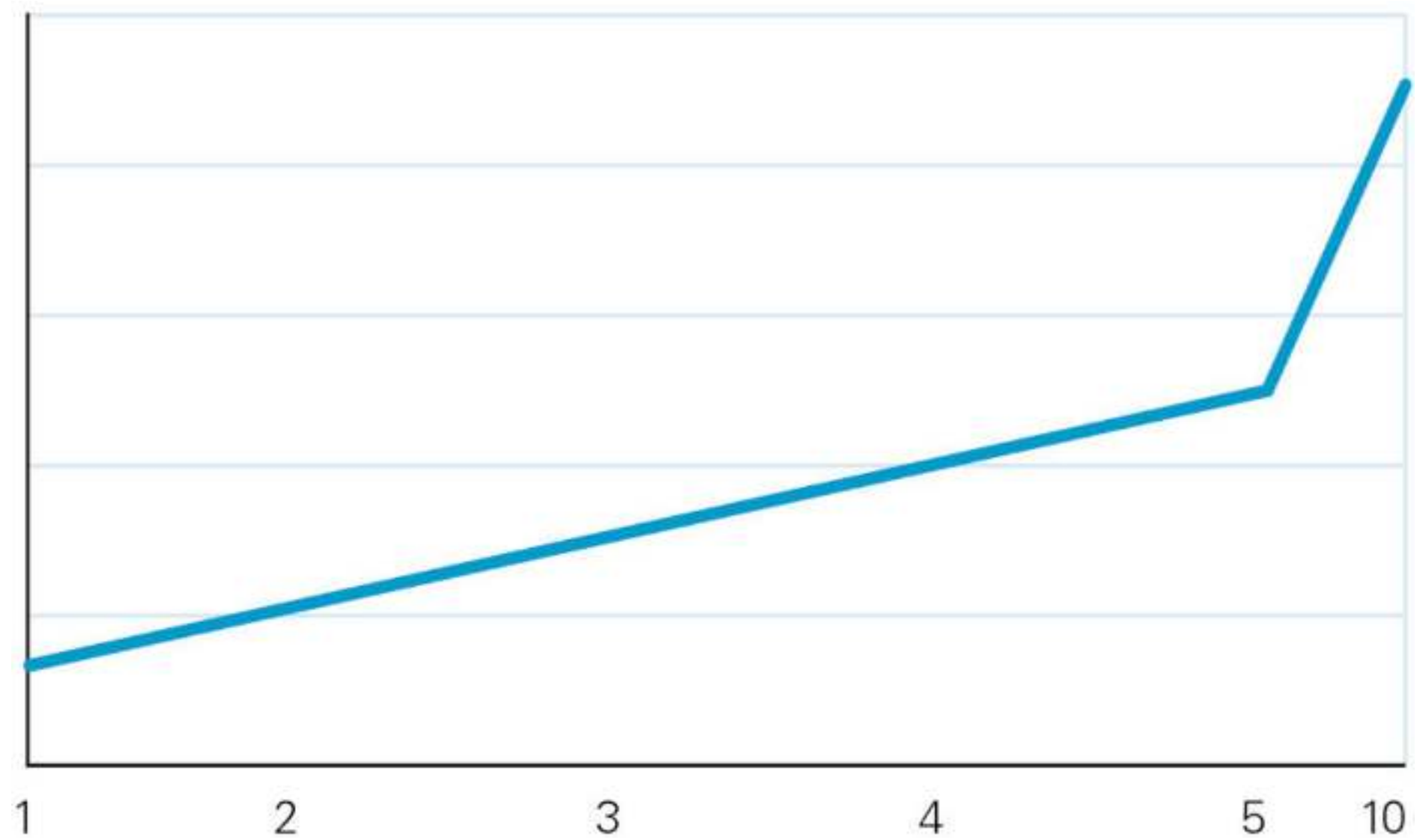
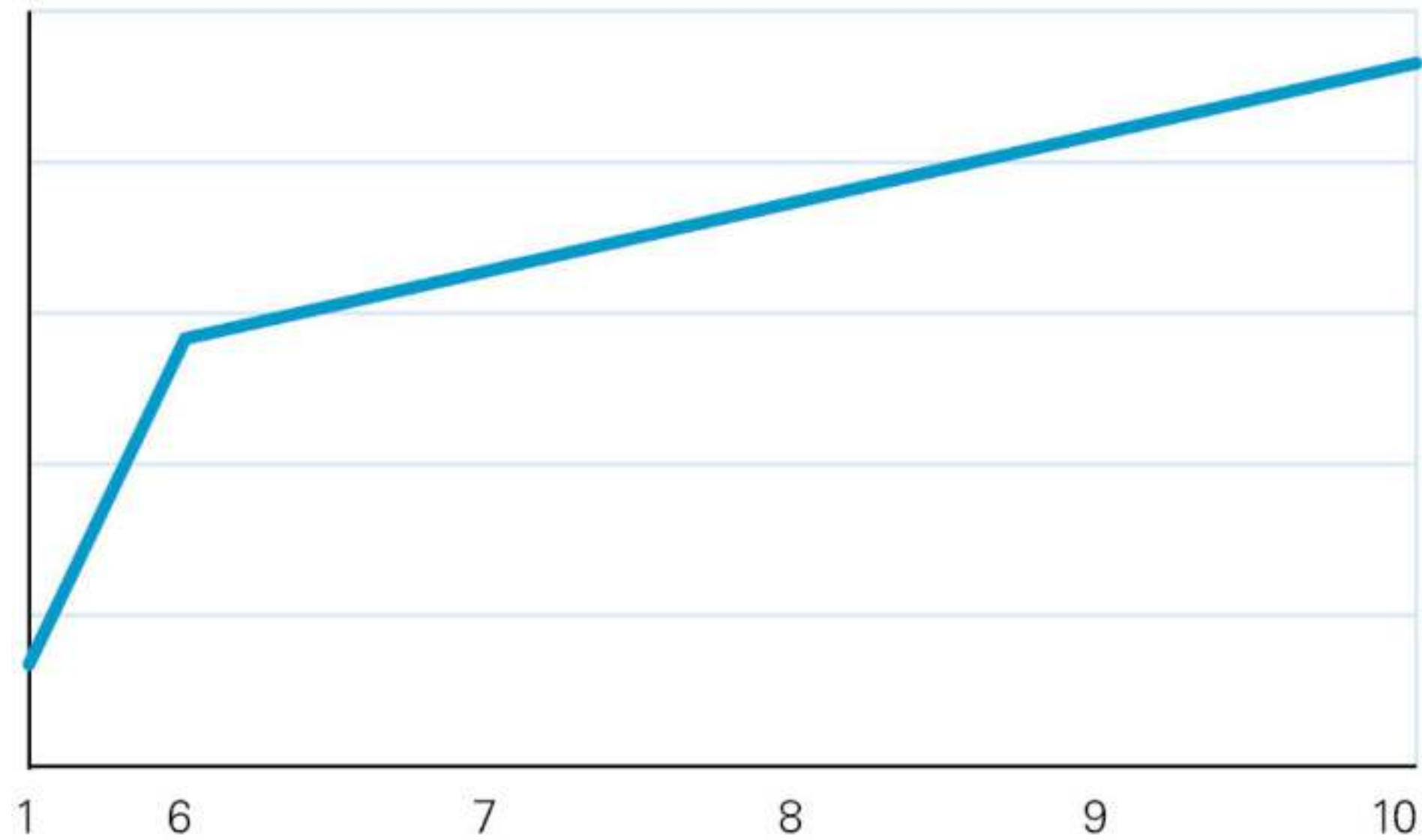

Partial Expansion /
Compression of Axis

Trust only the statistics that you have falsified yourself

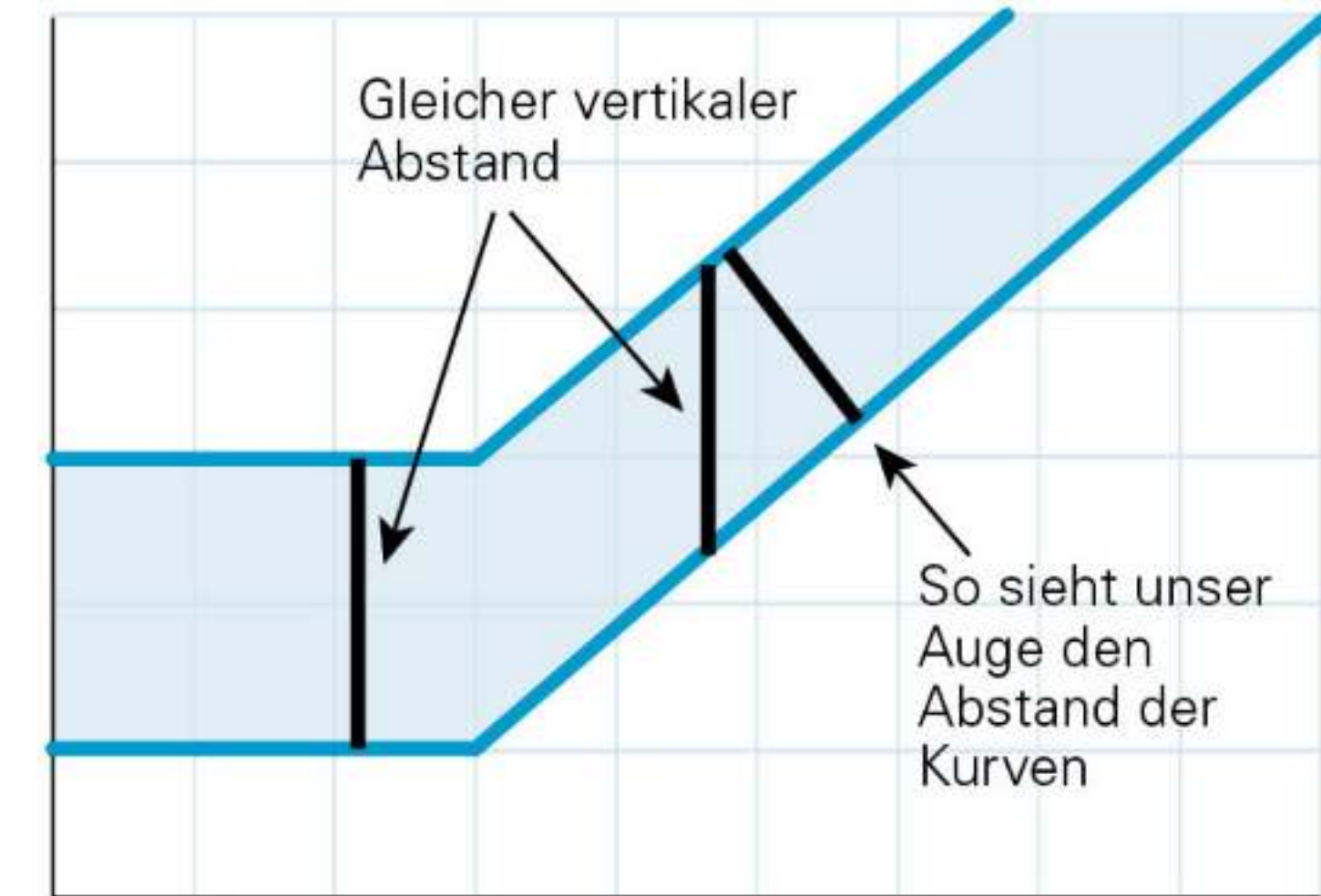
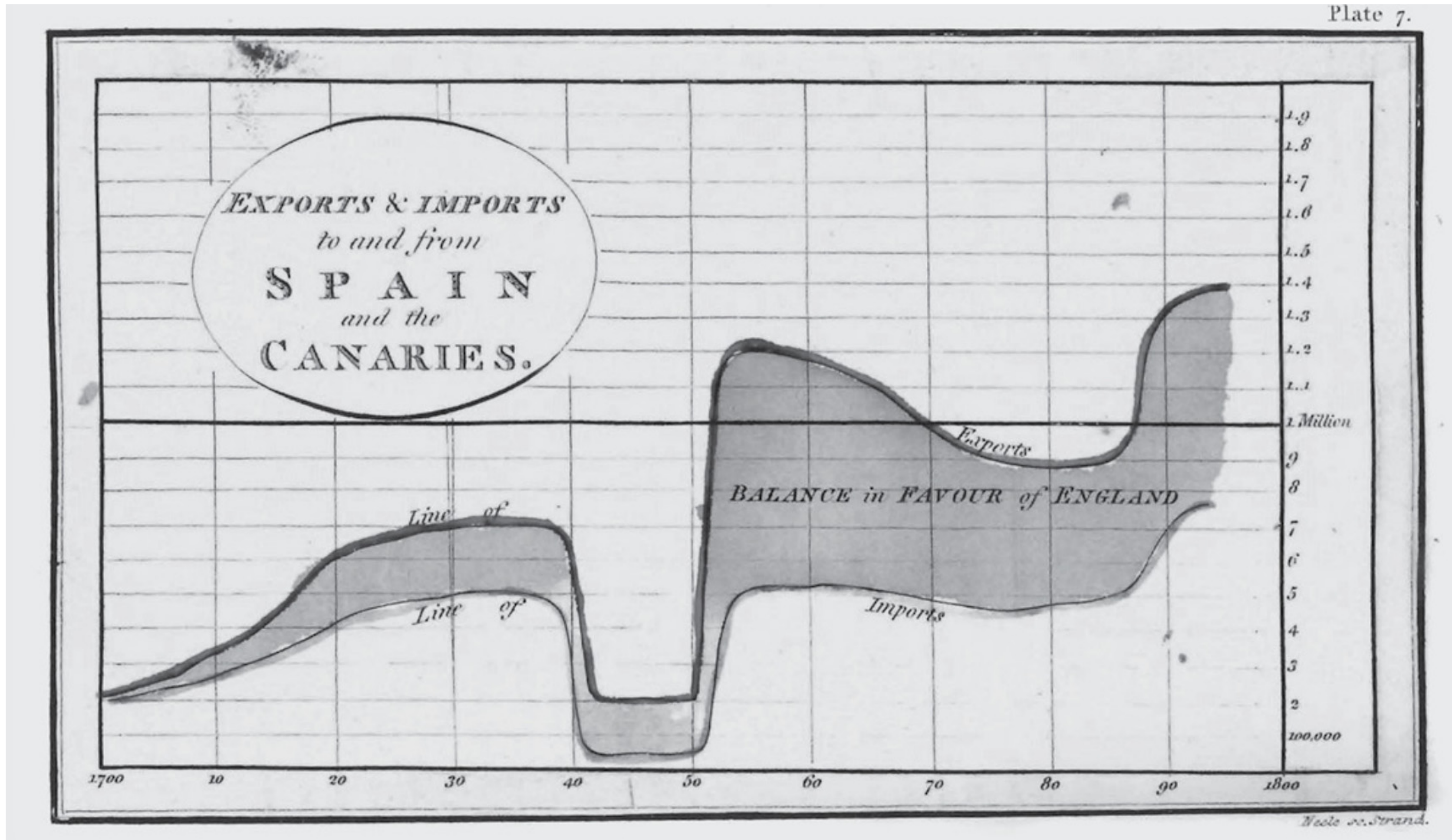

Our eye interprets distances not perpendicularly, but orthogonal

The thing with curves

Trust only the statistics that you have falsified yourself



A



B

In both cases edge lengths were doubled.

B's area is 4 times the area of A

B's volume 8 times the volume of A



A



B

Perception of Areas and Volumes

Trust only the statistics that you have falsified yourself



World's population:

- 1950: 2,5 Billion
- 2050: 9,2 Billion

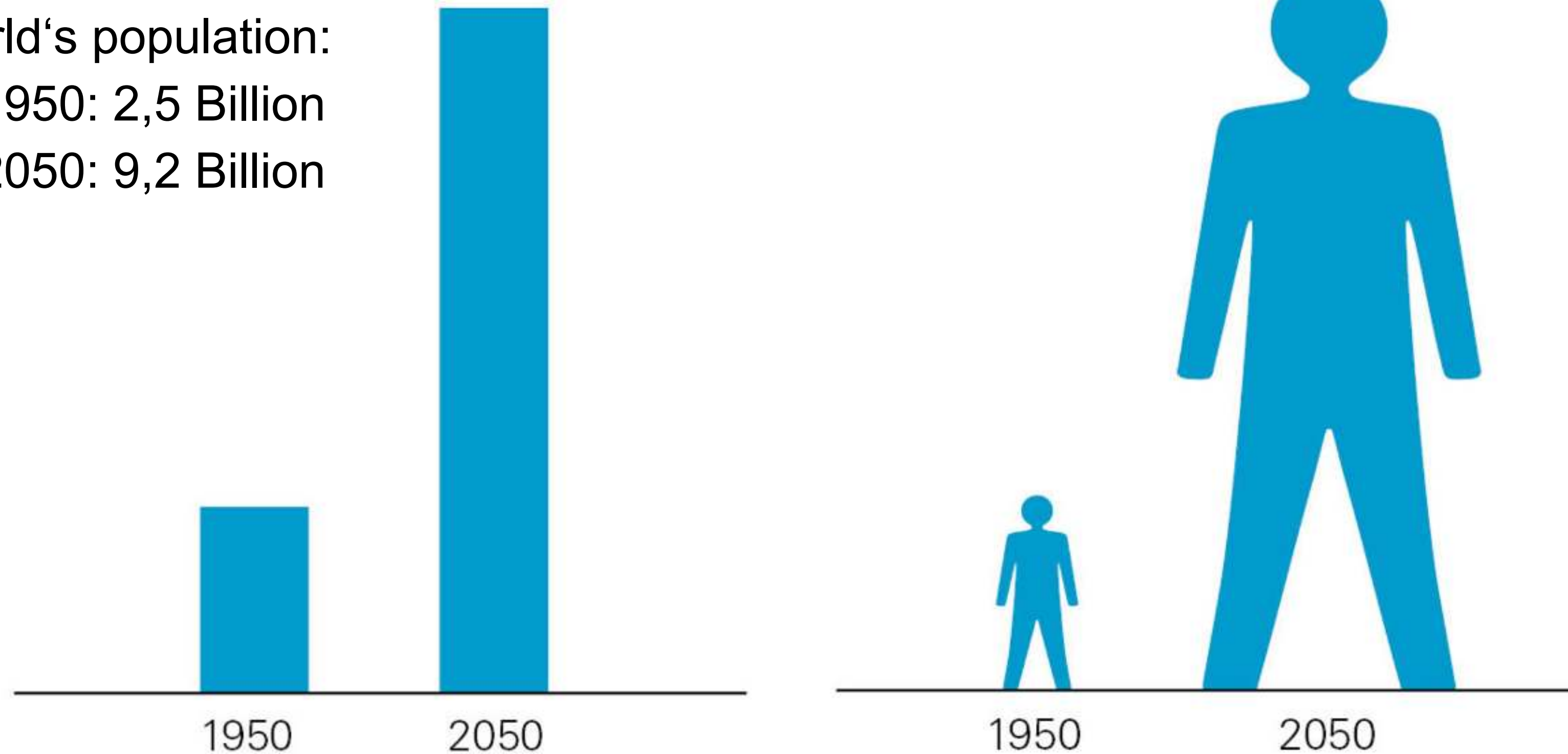

Pictograms have height and width scaled with ratio 2,5:9,2.

The ratio of areas becomes 2,5:33,8!

Stacking the pictograms further perturbs the perception of ratios.

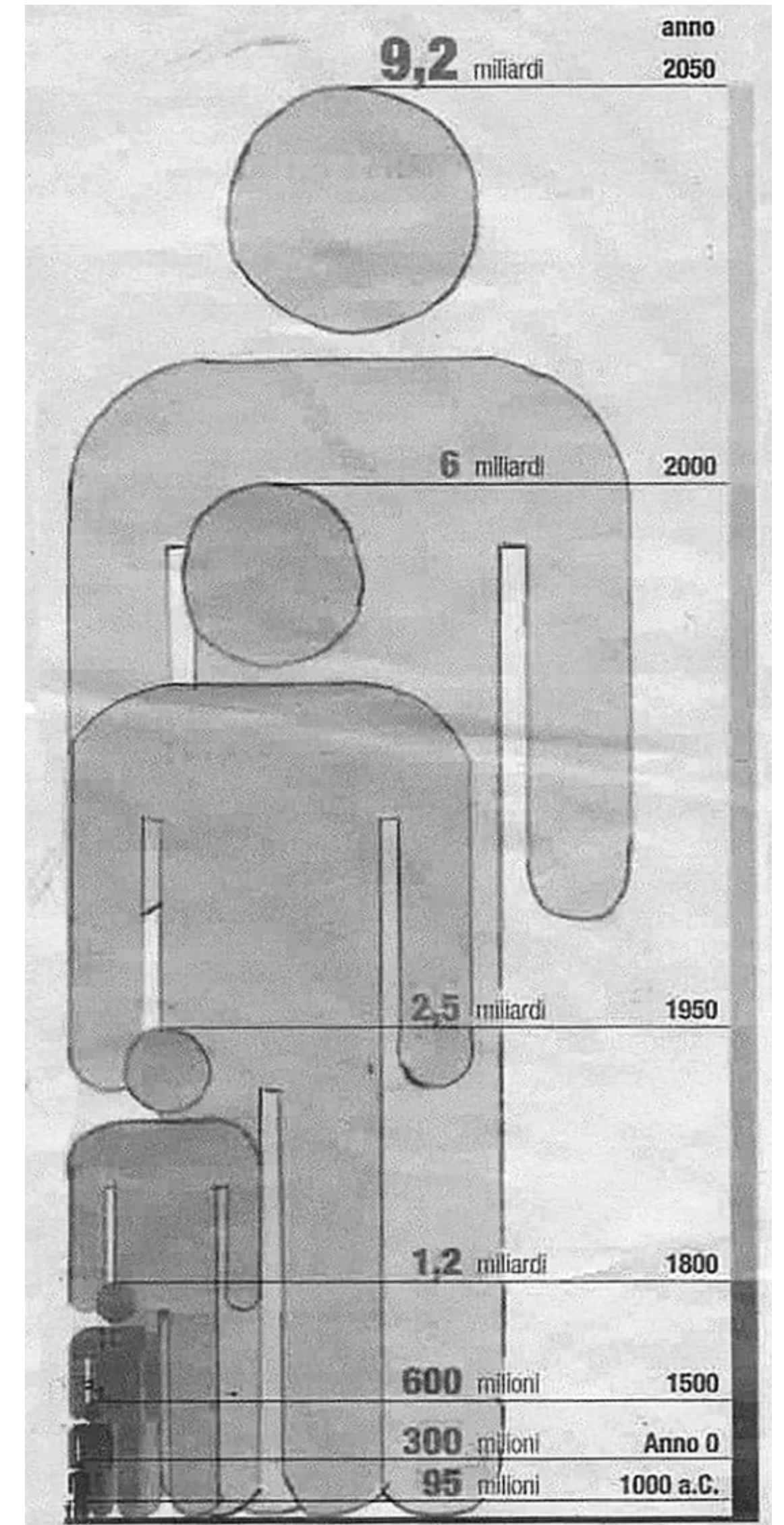

Graphical Integrity

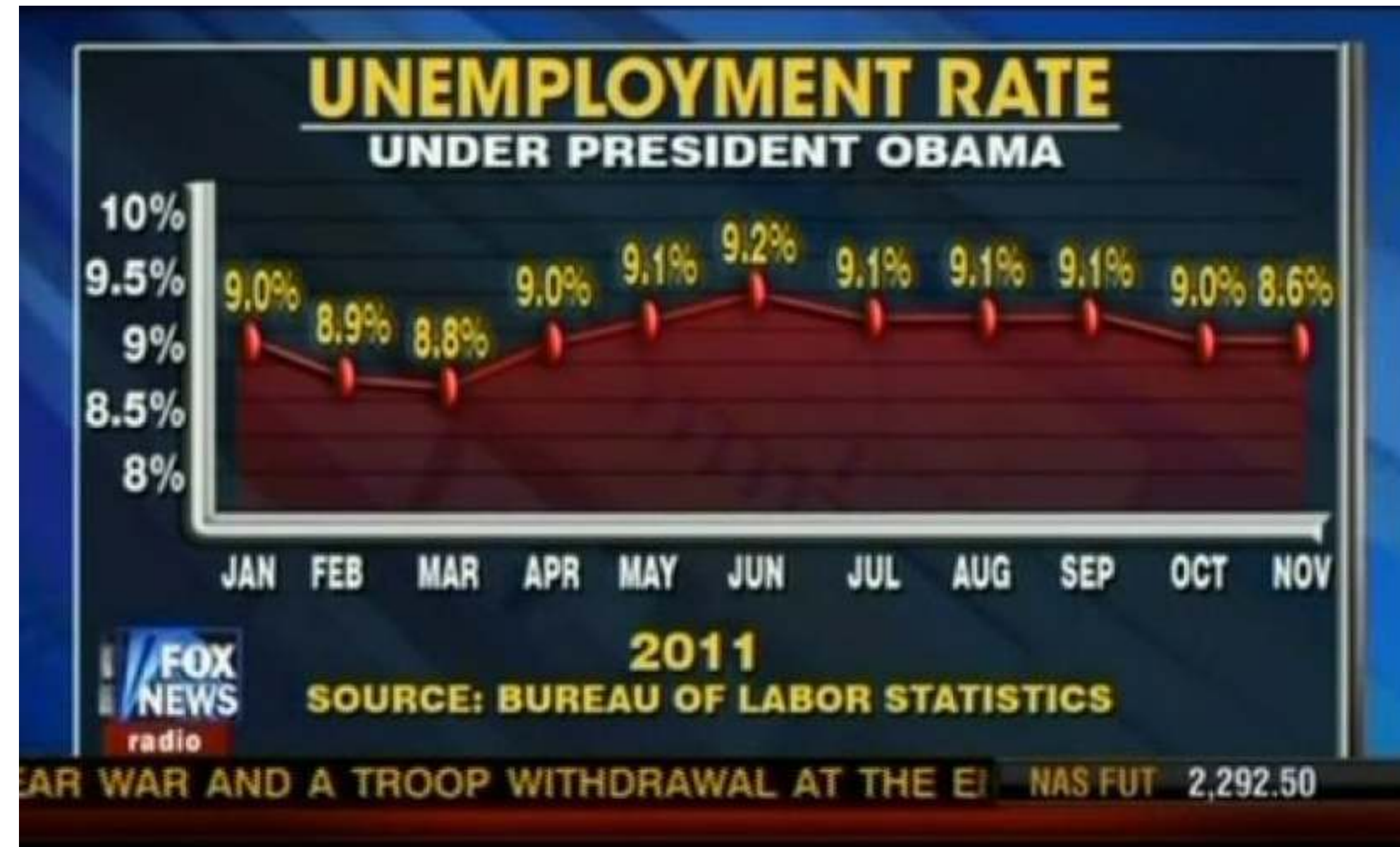

As to the propriety and justness of representations sums of money, and time, by parts of space, tho' verey readily agreed to by most men, yet a few seem to apprehend that there may possibly be some deceptions in it, of which they are not aware

William Playfair,
The Commercial and Political Atlas (1786) [Tufte2001]

Color

Colors: Get it right in black and white

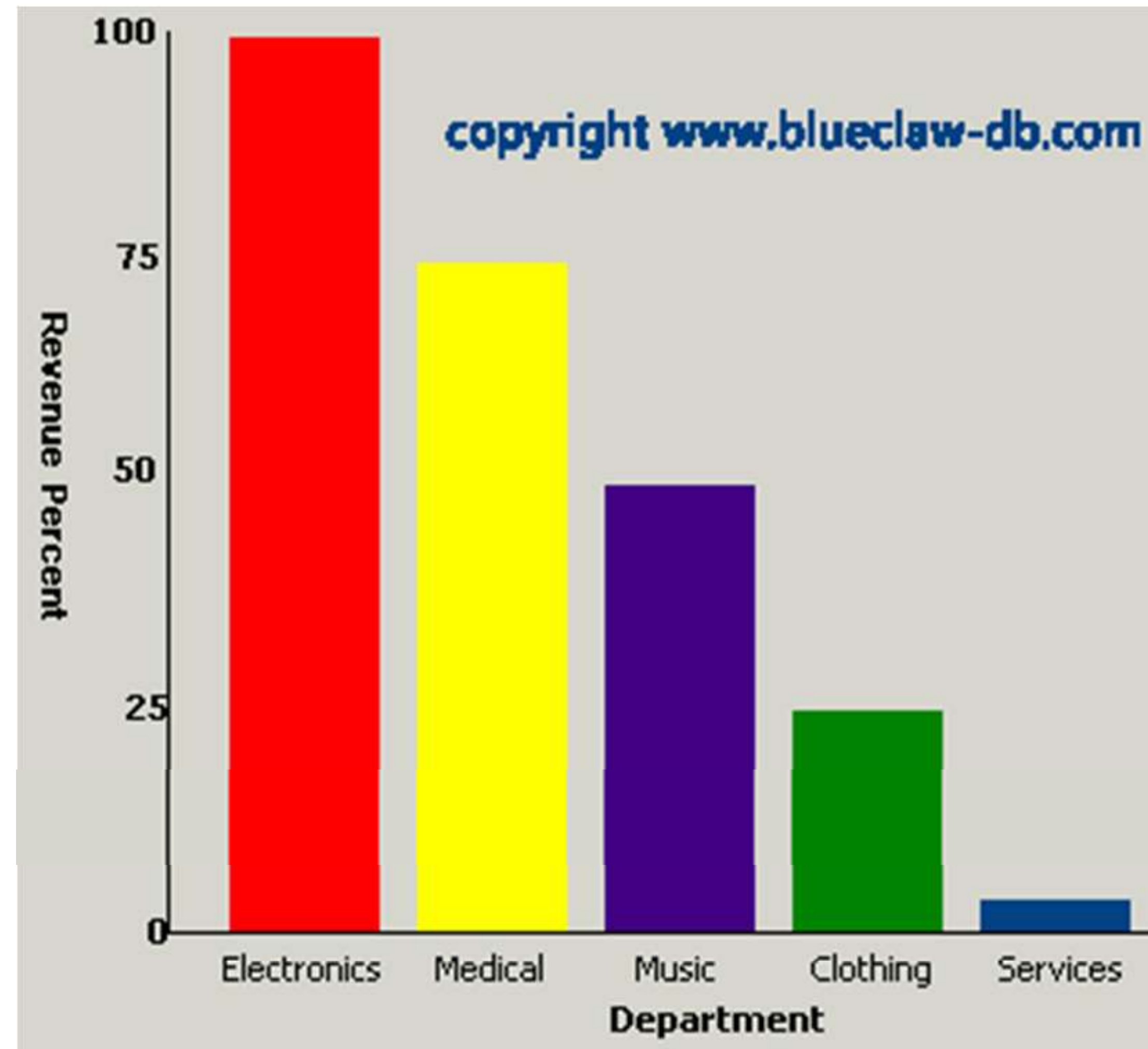

Color

- Create a color scheme
- Be consistent across visualizations
- Do your colors carry additional information?

Caveat: Colors often have meaning

Online tools can assist you in creating appealing palettes

<https://paletton.com/>

<https://colorbrewer2.org/>

<https://www.toptal.com/designers/colorfilter>

...

Online Tools (among others)



<https://paletton.com/>

<https://colorbrewer2.org/>

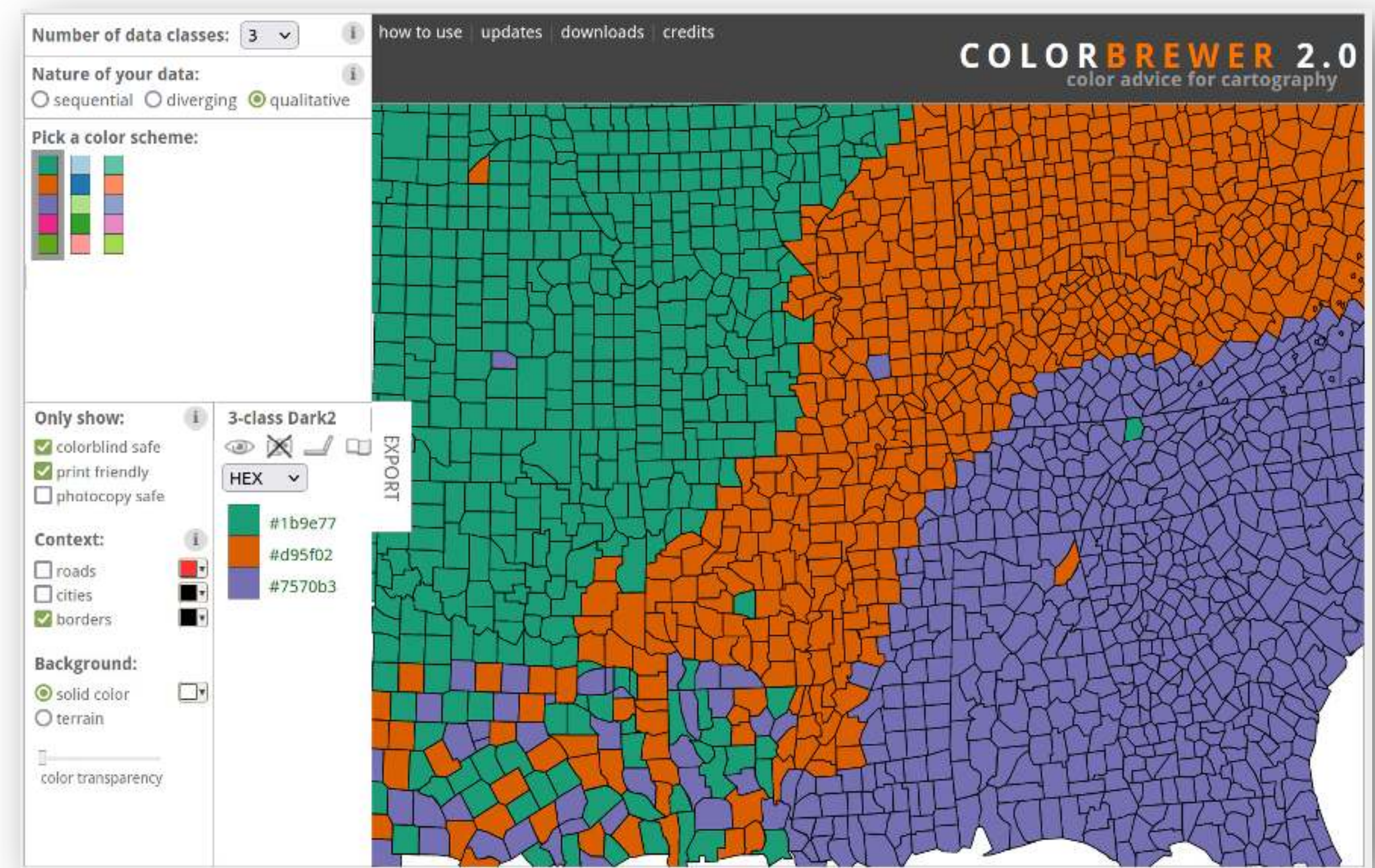

Example: Paletton.com

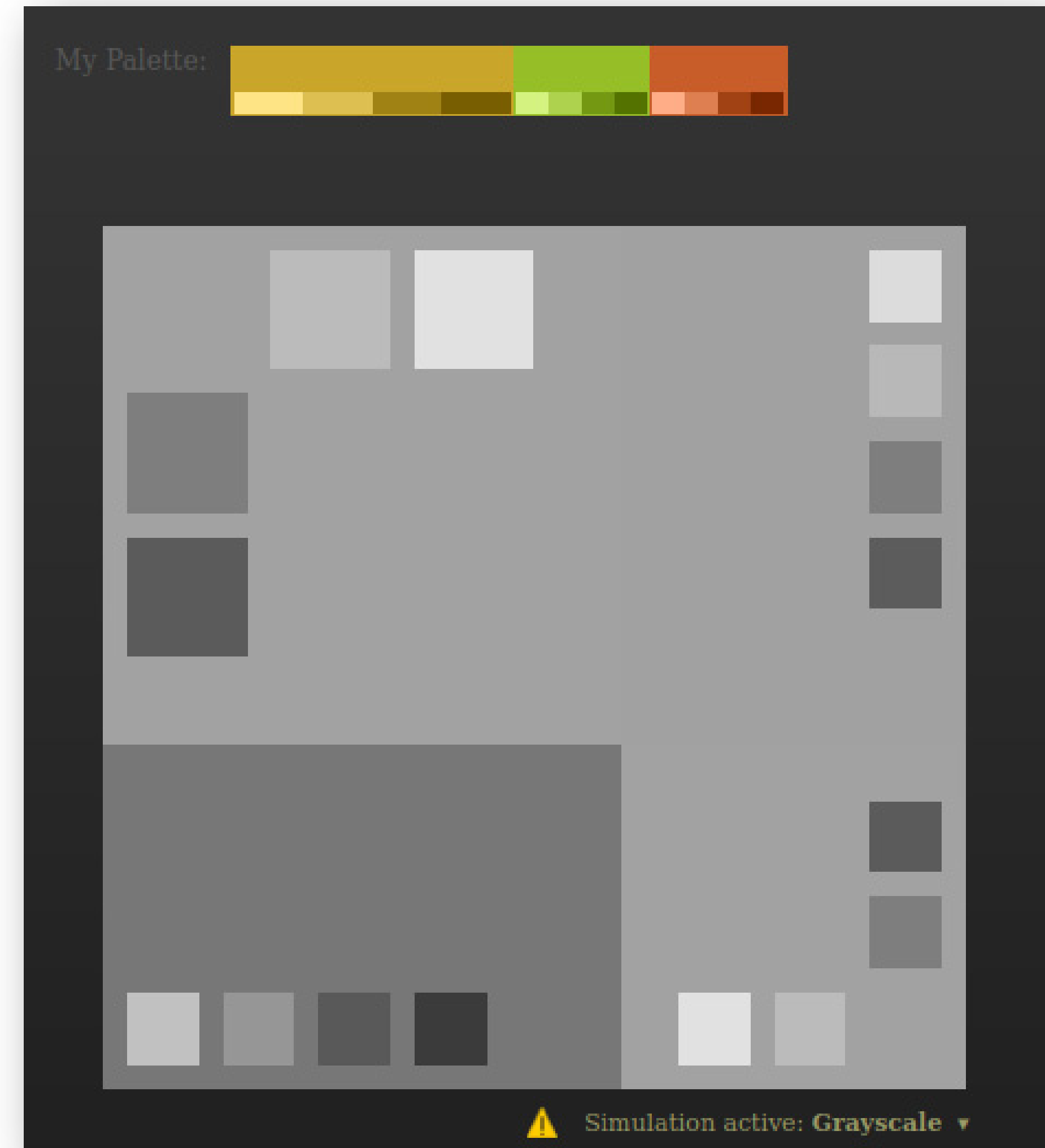
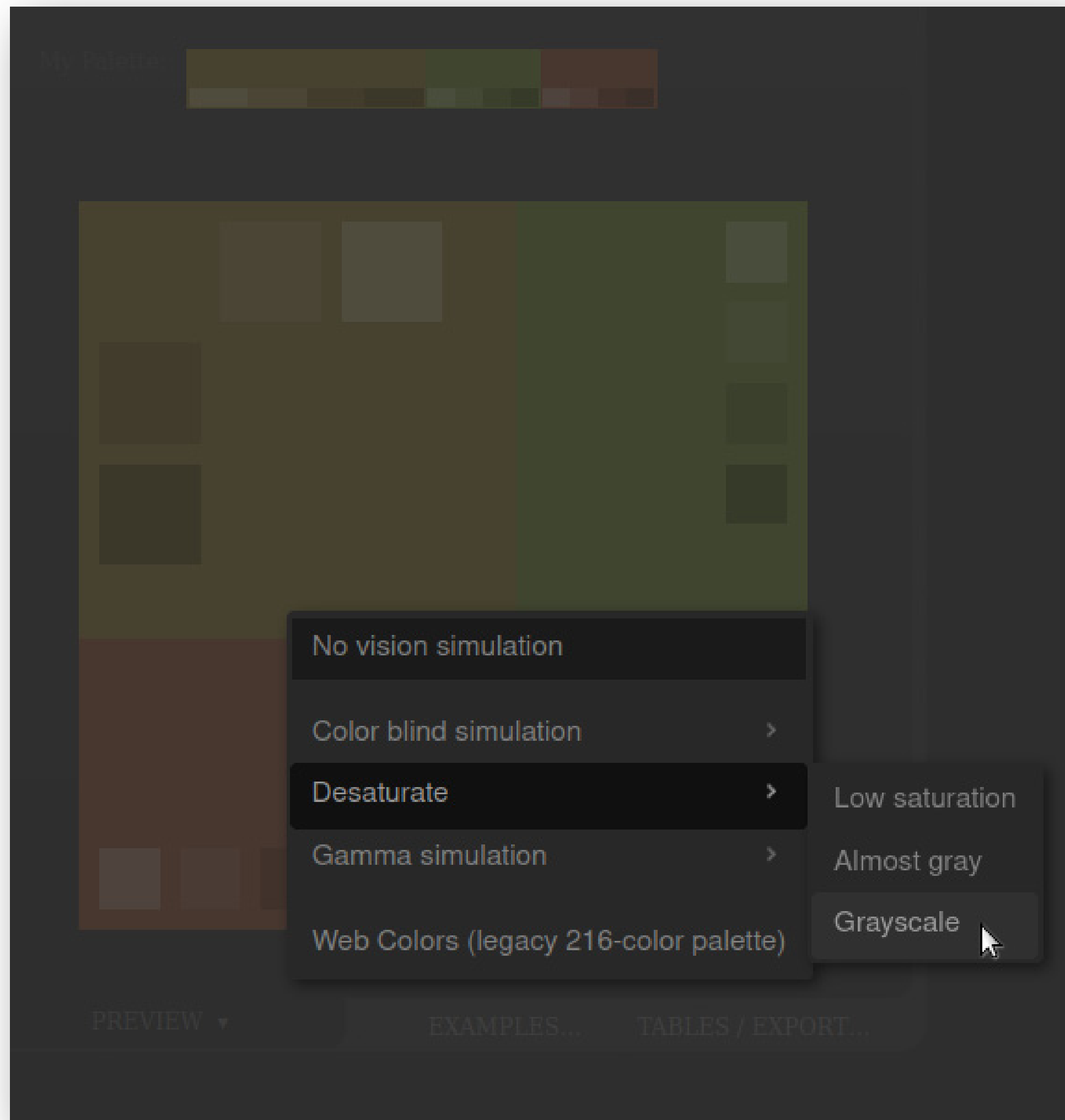

Optimize colors for brightness, not hue!

The Cubehelix color scheme is optimized for color scales as it varies in hue and value to retain contrast



The „rainbow“ scale would be inefficient for gradual differences when viewed in grayscale!

Color Blindness

Decreased ability to see color or differences in color

- Deuteranomaly (most common): affects 6% of males, 0.4% of females. „Green weakness“
- Protanomaly: affects 1% of males, 0.01% of females. less sensitive to red light
- Deuteranopia: affects 1% of males.
- Protanopia: affects 1% of males.
- Tritanopia: <1% of males and females.
- Tritanomaly: < 0.01% for males and females.

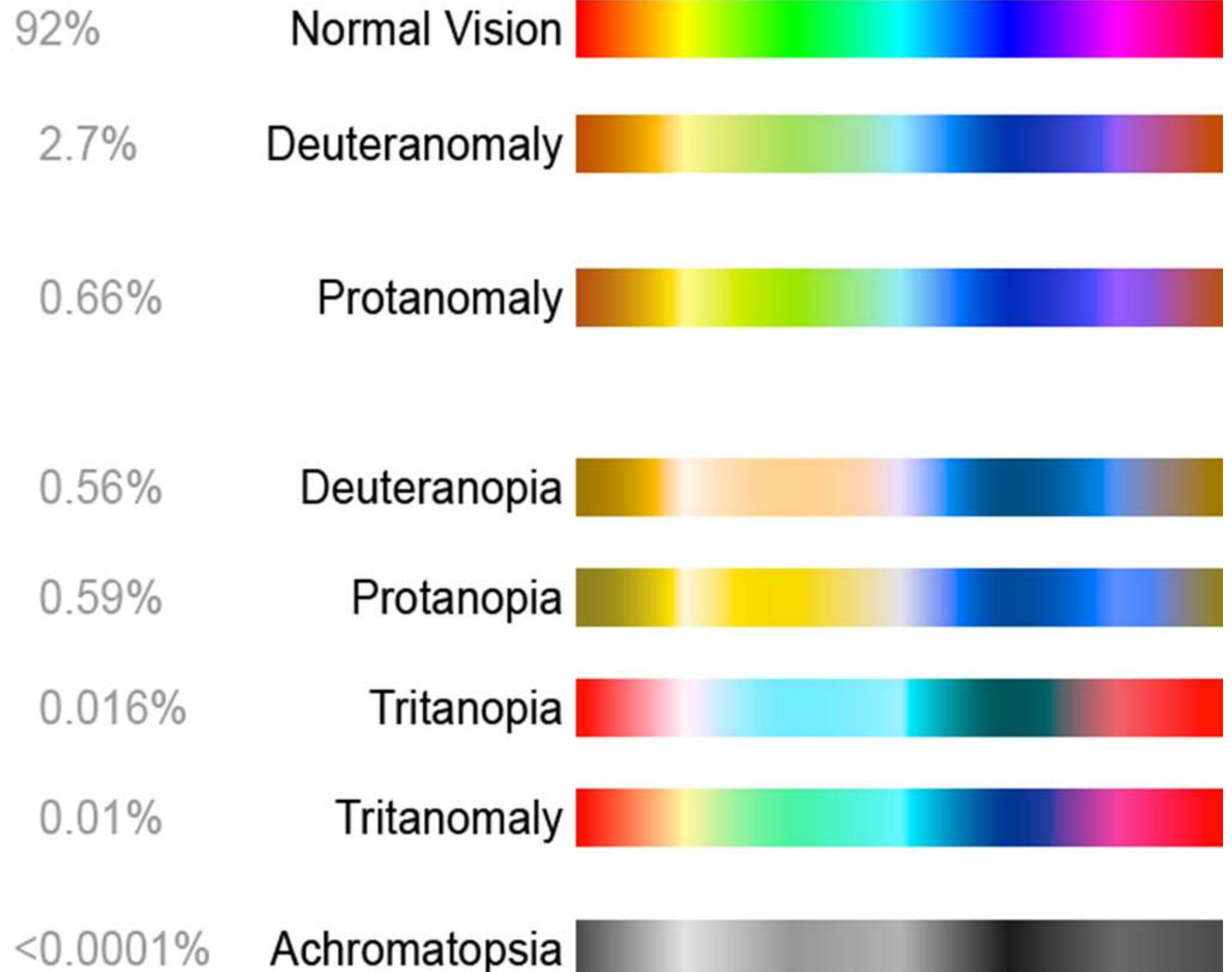

Color Scheme for Color Blindness

Thanks to the constant change in saturation, the cubehelix color scheme provides enough discriminative power for various deficiencies

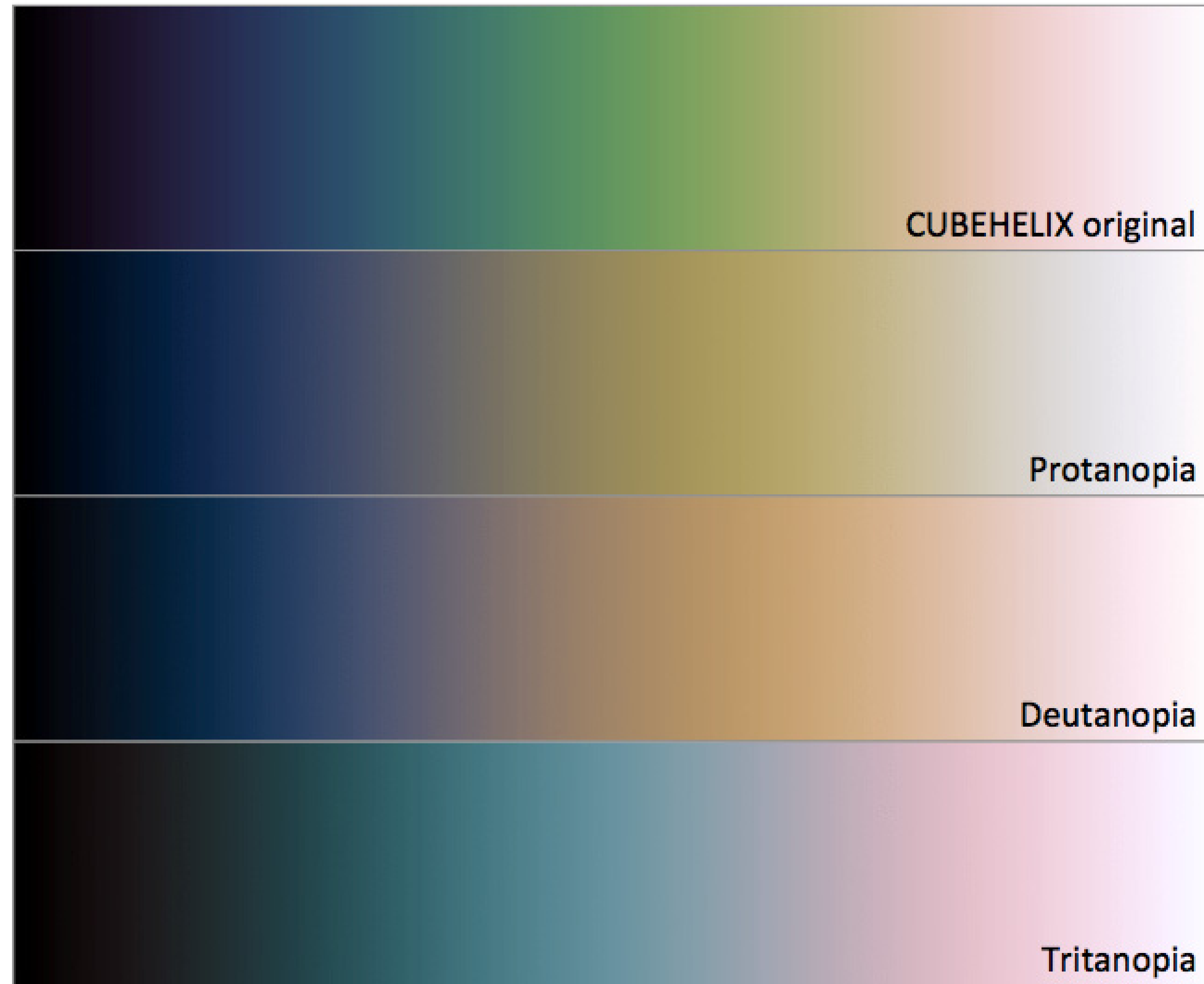

Vision simulations

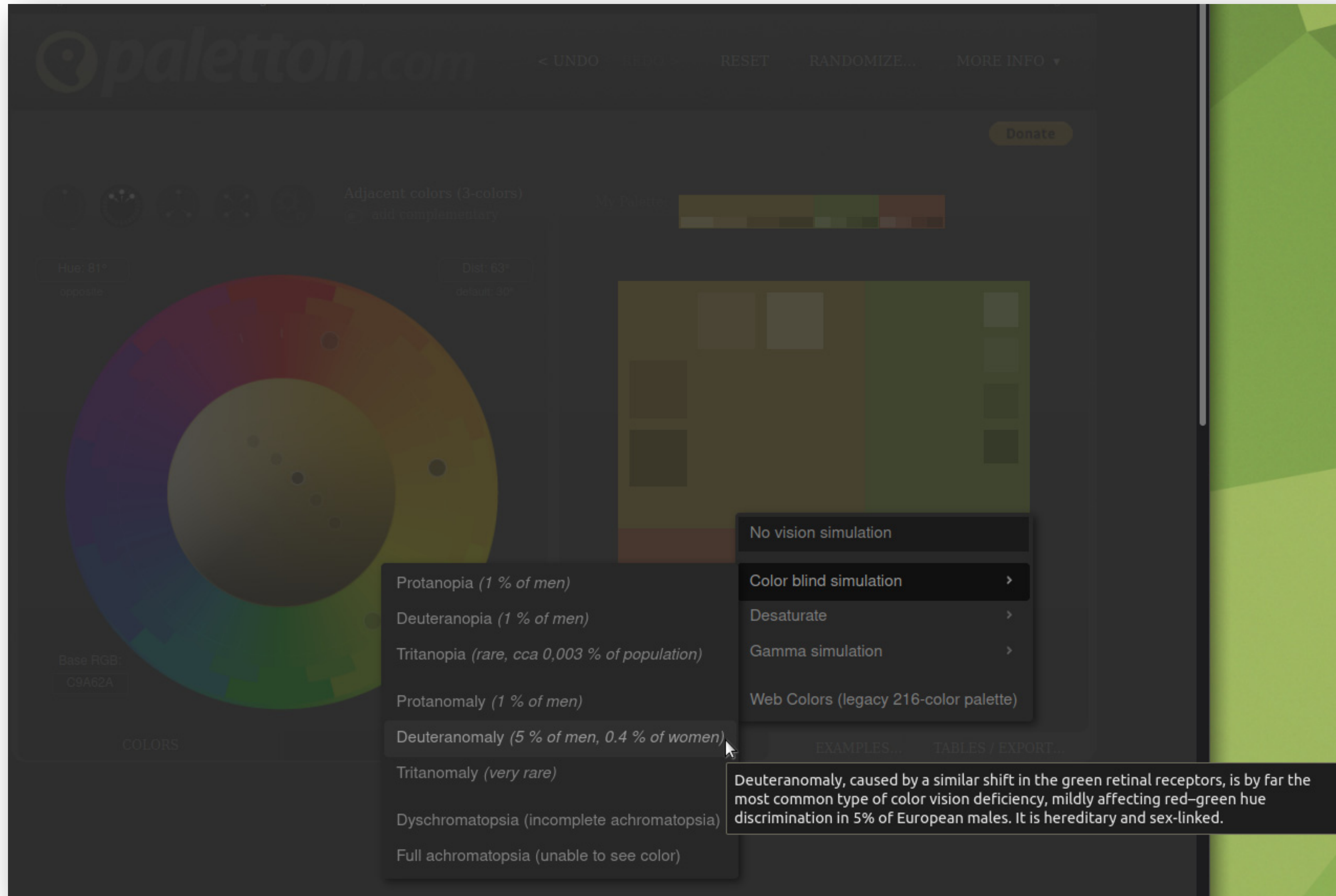

The image shows a screenshot of the Dalton simulator interface. The main area displays a color palette with a central circle and a surrounding ring. The palette is labeled "COLORS" and shows a base RGB value of C9A62A. A dropdown menu is open, listing various vision simulation options. The selected option is "Deuteranomaly (5 % of men, 0.4 % of women)". A tooltip provides additional information about Deuteranomaly.

Base RGB: C9A62A

Adjacent colors (3-colors)
add complementary

Hue: 81°
default: 0°

Dist: 63°
default: 30°

Protanopia (1 % of men)
Deuteranopia (1 % of men)
Tritanopia (rare, cca 0,003 % of population)
Protanomaly (1 % of men)
Deuteranomaly (5 % of men, 0.4 % of women)
Tritanomaly (very rare)
Dyschromatopsia (incomplete achromatopsia)
Full achromatopsia (unable to see color)

No vision simulation
Color blind simulation >
Desaturate >
Gamma simulation >
Web Colors (legacy 216-color palette)

Deuteranomaly, caused by a similar shift in the green retinal receptors, is by far the most common type of color vision deficiency, mildly affecting red-green hue discrimination in 5% of European males. It is hereditary and sex-linked.

Wrap-Up



Graphical excellence

is a matter of substance, statistics, and design

consists of complex ideas communicated with clarity, precision, and efficiency

give the viewer the greatest number of ideas in shortest time with

the least ink in the smallest space

is nearly always multivariate

requires telling the truth about the data

induce the viewer to think about the substance rather than the methodology

Information Visualization is a Form of Communication

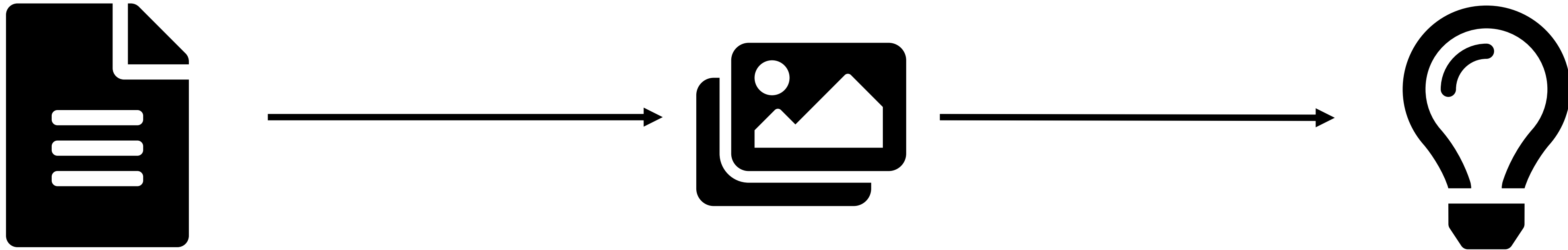

How to support effective communication:

- Explain mapping of data to visual elements
- Be consistent also across visualizations
- Use graphical elements to support your narrative

Acknowledgement



Thanks to Jürgen Pfeffer and his lecture on information visualization!

Thanks.

mirco.schoenfeld@uni-bayreuth.de